



ADO 260

Drying Oven

Operation Manual

AMOS SCIENTIFIC PTY.LTD. ABN37 159 778 140

www.amos-scientific.com



Foreword

Thank you for purchasing our Oven. Presented in this 《Operation Manual》 are the functions and operation methods of the Slide Dryer and the matters needs attention for safety reasons. Please carefully read this manual before using so that you can understand its functions better and make full use of the products. If you have any questions, please contact us and we will provide best service for you at any time.

Please keep this 《Operation Manual》 appropriately for later consultation.





Contents

1. Safety Matters	1
2. Main Structures&Functions characteristics apply condition.....	2
3. Technical Data	2
4. Operation Manual	3
5. Wire Diagram of Electric	7
6. Schematic Diagram	8
7. Maintenance Manual.....	8



1. Safety Matters

1.1 Safety attentions

● Please read these explicit rules. Act in violation of them can affect normal operation of the equipment, causing damages to the equipment or resulting in dangers.



Please use 220V±10%, 50Hz or 110V±10%, 60Hz AC..



Input power supply must be of good earth connection.



Keep away from flammables and explosives.



Don't open equipment without authorization to avoid high voltage shock.



Only professional maintenance personnel is allowed to repair equipment.



Use fuses with correct capacity.



Ensure power socket and circuit be able to bear 2 times of rated current at least.



Keep away from from any interference source.



Caution: Hot .

1.2 Conditions of installation

- (1) Ensure more than 20cm of space around the equipment for heat dissipation
- (2) No water drop, steam, dust including oily dust and floating dust
- (3) No erosive, flammable and explosive gas and liquid
- (4) Solid and non-vibration
- (5) No interference from other electromagnetic signals
- (6) Operating ambient temperature from +10°C to +30°C, relative humidity under 90%

1.3 Delivery inspection

Product has been through strict inspection by quality management before ex-factory. However, product may be damaged or partially lost due to negligence or severe clash during delivery. Thus.

- (1) Please check the contents inside including equipment, operation manual, packing list and spare parts after unpacking..
- (2) Check nameplate to ensure it is your order..
- (3) Make sure of no damage or loss during delivery.

2. Main Structures & Functions characteristics apply condition

2.1 The Oven is made of sheet aluminum and has the advantages of artistic appearance, non touchable temperature control, stable performance, program control system and easy and reliable operation. It is mainly used for flattening and drying of the microtome sections of tissues , as pic 1

2.2 Main Structure, as Pic 1 .

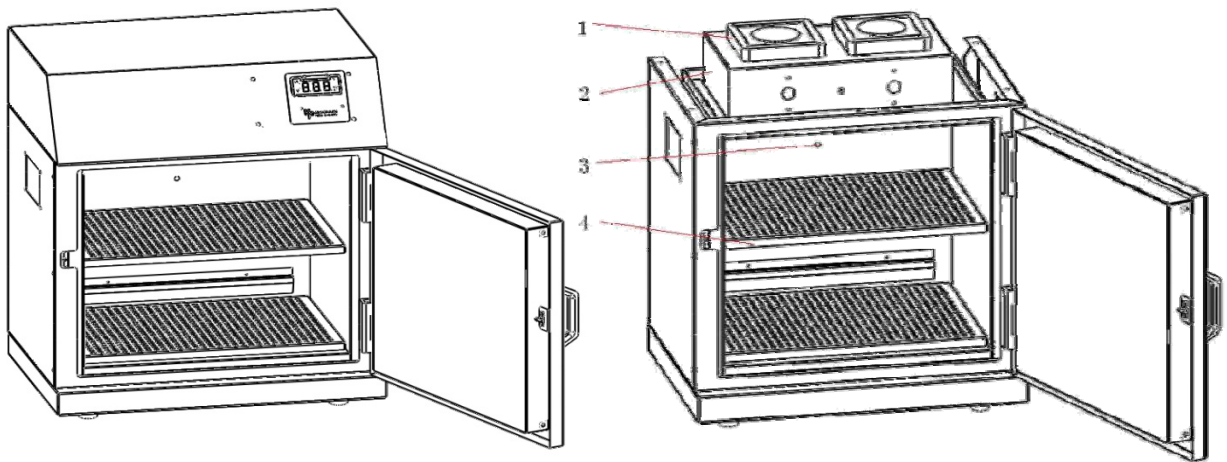

Pic 1

Pic 2

① Fan ② Heater ③ Temperature sensor ④ Tray

3. Technical Data

- Inside dimensions: 290mm × 400mm × 350mm
- Temperature range: 30~80°C
- Temperature control accuracy: ±1°C
- Rated voltage: 220V±10%50HZ
- Rated power: 850W (Heater power: 800W)
- Outside dimensions (W×D×H): 360mm × 500mm × 620mm
- Weight: 33Kg

4. Operation Manual

4.1. Control Panel

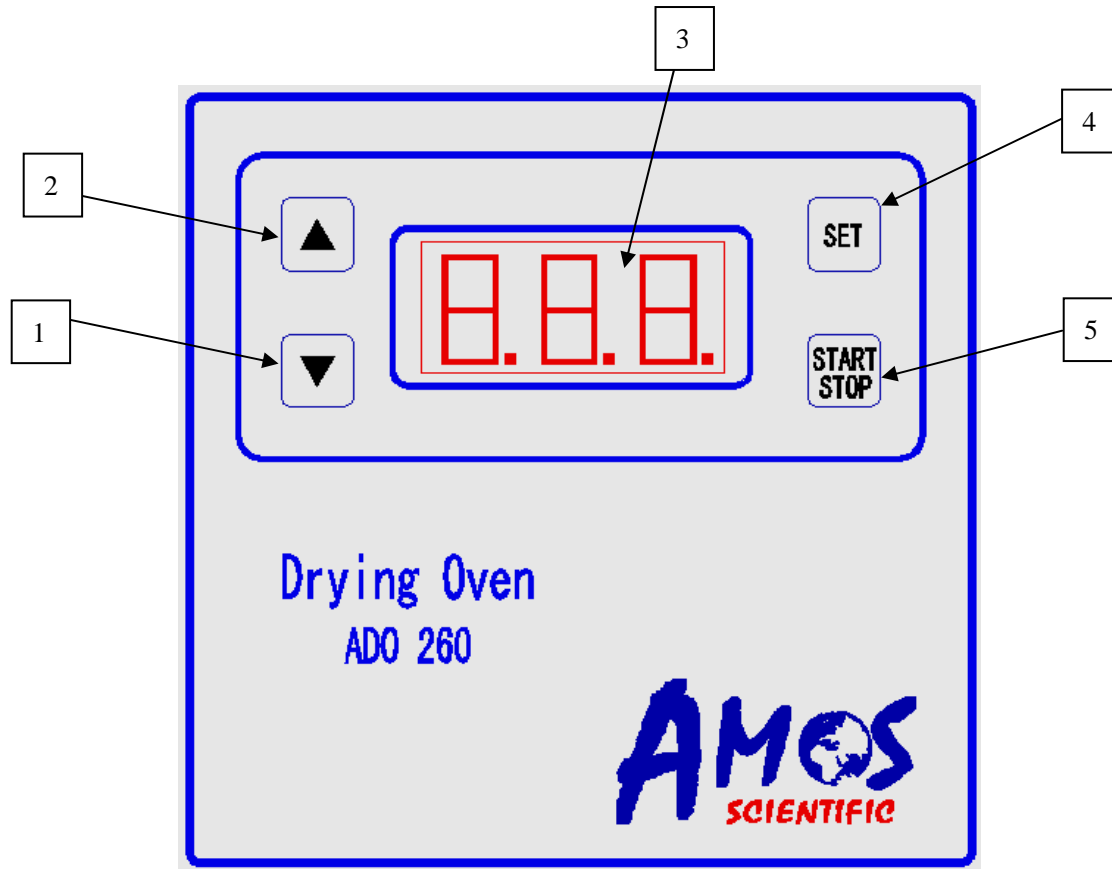

Pic 3

The control panel is made up of : (As pic 3)

- 1) "▲" and "▼" keys: Page up and down or increase and decrease the parameters
- 2) A Led to show temperature , setting time and parameters and so on
- 3) SET key: Set the parameters
- 4) Start/Stop key: Control the oven

4.2. Instructions

- 1) Before operation ,check whether every part of the machine is in normal condition .
- 2) Connect the machine to power and turn on the switch at the back cover ,while the buzzer beeps and shows "----" on the panel , and then shows ambient temperature after about 1 second that means the machine is in normal working condition .At this moment , it heats as the preset temperature .
- 3) Press start/stop key to start the heating as preset temperature , while the LED shows time

and enter into countdown state . It will show “000”after the end of countdown (If the buzzer is turned on , it reminder by beeping) , at this moment it can be back to preheat status by pressing any key .

4)Under both preheating and heating status , it can check the present oven temperature ,temperature of heating element on the top and countdown timer status by pressing UP&DOWN keys .

4.3. Parameters setting

1) Under oven temperature showing status ,hold UP&DOWN keys simultaneously for more than 2 seconds into parameter setting menu (as pic 4),then check each item and its value by UP&DOWN keys . When it shows the setting value , press SET again the value will flicker . At this moment edit the value by UP&DOWN keys . After editing , press SET again to quit editing status .Then set the other item by the same way . After setting all the item , press SET key to quit parameter setting status (Wait for 5 seconds or press START/STOP to key to quit and switch Preheating/Heating status)

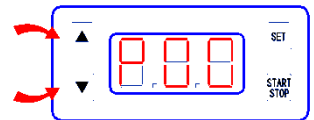

Pic 4

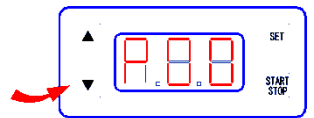

Pic 5

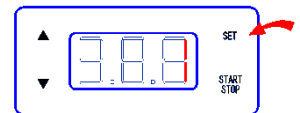

Pic 6

2) Preheating Time setting :

a) Hold both“▲”and “▼”keys for more than 2s till the LED shows “P00” .(As pic 4)

b) Press “▼”to find time setting item .(As pic 5)

c) Stay in time setting status , and press “SET” again . Then the time value flickers that means it enters into editing mode . Now adjust the value by “▲”and “▼”keys , then press “SET” to quit editing mode .(As pic 6)

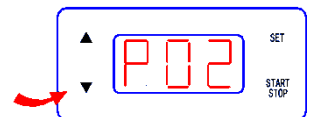

Pic 7

d) Press “▼”page down to item “P02”to confirm the time unit (the default is “1” means the unit is minute) . Please press “SET” again into value editing mode to modify to desired time unit , then quit by pressing “SET” .(As pic 7-8)

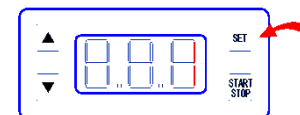

Pic 8

e) Press “▼”page down to item “P06”,and press “SET” into editing mode and then press “▲”and “▼”to modify the value , then press “SET” again back to browse mode . (As pic 9-11)

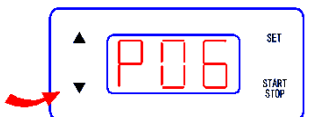

Pic 9

f) When Press “▲”and “▼”till it shows “Pxx”(xx=00-16), press “SET”(or wait for 5s) to quit the modifying menu to finish the time setting .Please note to implement the timing heating function : it has to make the time value , time unit both corrective and activate this function when turn on the machine .

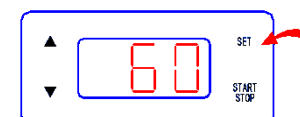

Pic 10

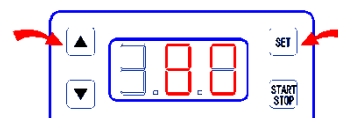

Pic 11

3) Temperature setting :

First way : (As pic 12-13)

- a) Hold both “▲” and “▼” keys for more than 1s till the LED shows “PO0” .
- b) Press “▼” page down till the LED shows “P05”, press “▼” again , the LED will show present temperature setting value .
- c) Press “SET” switch to editing mode , then press “▲” and “▼” to modify the value .After editing , press “SET” back to browsing mode .
- d) When Press “▲” and “▼” till it shows “Pxx”(xx=00-16), press “SET”(or wait for 5s) to quit the modifying menu to finish the temperature setting .

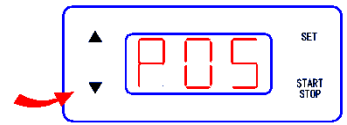

Pic 12

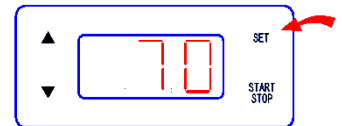

Pic 13

Second way : (As pic 14-15)

- a) Under oven temperature showing status , press “ set” into parameter setting menu . It shows the setting value with flicker . For example , the current temperature is 29°C , and press “SET” , it will show the default setting temperature , 70°C with flicker .
 - b) Press “▲” and “▼” to adjust the value to 65°C , and wait for 5s , it will be back to the status of showing actual temperature (or press START/STOP to key to quit and switch Preheating/Heating status)
- The above way is easier , which is used to adjust the setting temperature frequently .

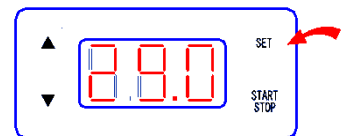

Pic 14

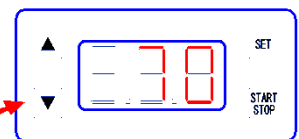

Pic 15

4) Preheating temperature setting.

There are two states after power on : warm-up state and heating state . Under warm-up state, the oven heats as preheating setting temperature . Under heating state , the oven heats as heating setting temperature . The main purpose of adding preheating function is to reduce the time from turning it on to reach the preset heating temperature and improve the efficiency . However , comparing with no preheating the energy consumption will increase accordingly . If not need preheating function , please set the preheating temperature value to minimum . In order to shorten the heating time , please set the preheating temperature value as high as possible . For example , if the heating temperature is 75 °C and preheating temperature is 60 °C , the oven just needs to heat 15 °C from 60 °C to 75 °C . Because of small temperature rise , heating time will be significantly reduced and heating efficiency is improved .

No.	Function description	Min	Max	Unit	Default setting
P00	Timer 0-off 1-on	0	1	---	1
P01	Buzzer 0-off 1-on	0	1	---	1
P02	Time unit 0-second 1-minute	0	1	---	1
P03	Temperature unit 0-Fahrenheit 1-degrees Celsius	0	1	---	1
P04	Temperature compensation	1	20	---	10
P05	Heating temperature	30	80	°C	70
P06	Time alarm	0	600	Sec/Min	100
P07	Time flickering digit	0	3	---	1
P08	Overheating protection	80	120	°C	100
P09	Heating system feedback intensity	1	100	---	12
P10	Heating system Prediction intensity	1	500	Sec	120
P11	Heating system prediction compensation	0	100	---	5
P12	System default loaded	0	1	---	0
P13	Reserve ,do not alter	0	2	---	1
P14	Temperature sensor 0-off 1-on	0	1	---	1
P15	LED flickering frequency	1	20	Hz	8
P16	Preheating temperature	30	60	°C	50

Sheet 1,parameter setting

4. Explanation of alarm signal

When the LED shows E01-E05 , it means something wrong with the instrument :

- E01** The inside oven temperature sensor is over-temperature :the sensor is broken or the solid state reply can not disconnected ;
- E02** The over-temperature protection sensor alarms : the sensor is broken or the solid state reply can not disconnected ;
- E03** The oven chamber sensor is broken ;
- E04** The over-temperature protection sensor is broken ;
- E05** The heating film doesn't work : oven chamber sensor is broken or heating film and solid state reply is broken .

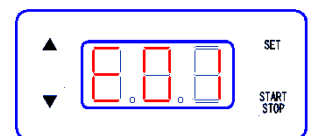

Pic 16

5. Wire Diagram of Electric

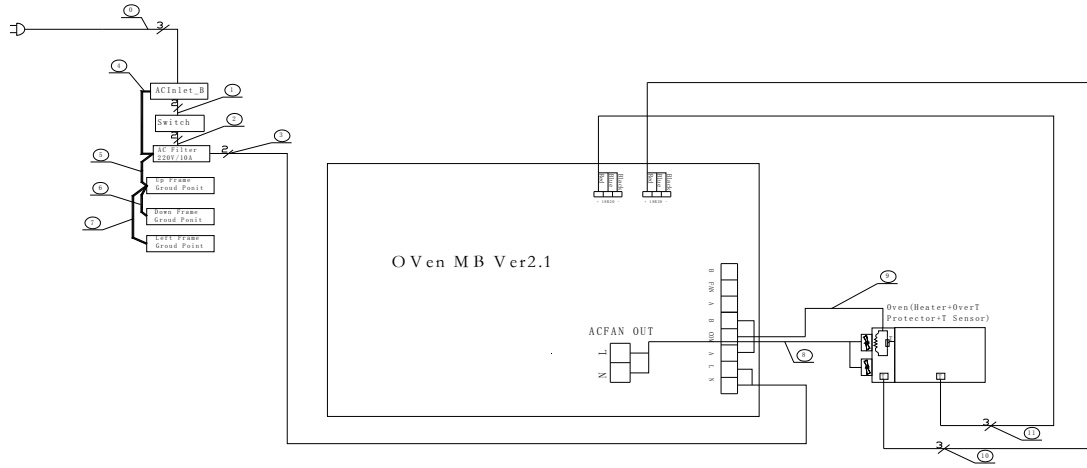

7. Schematic Diagram

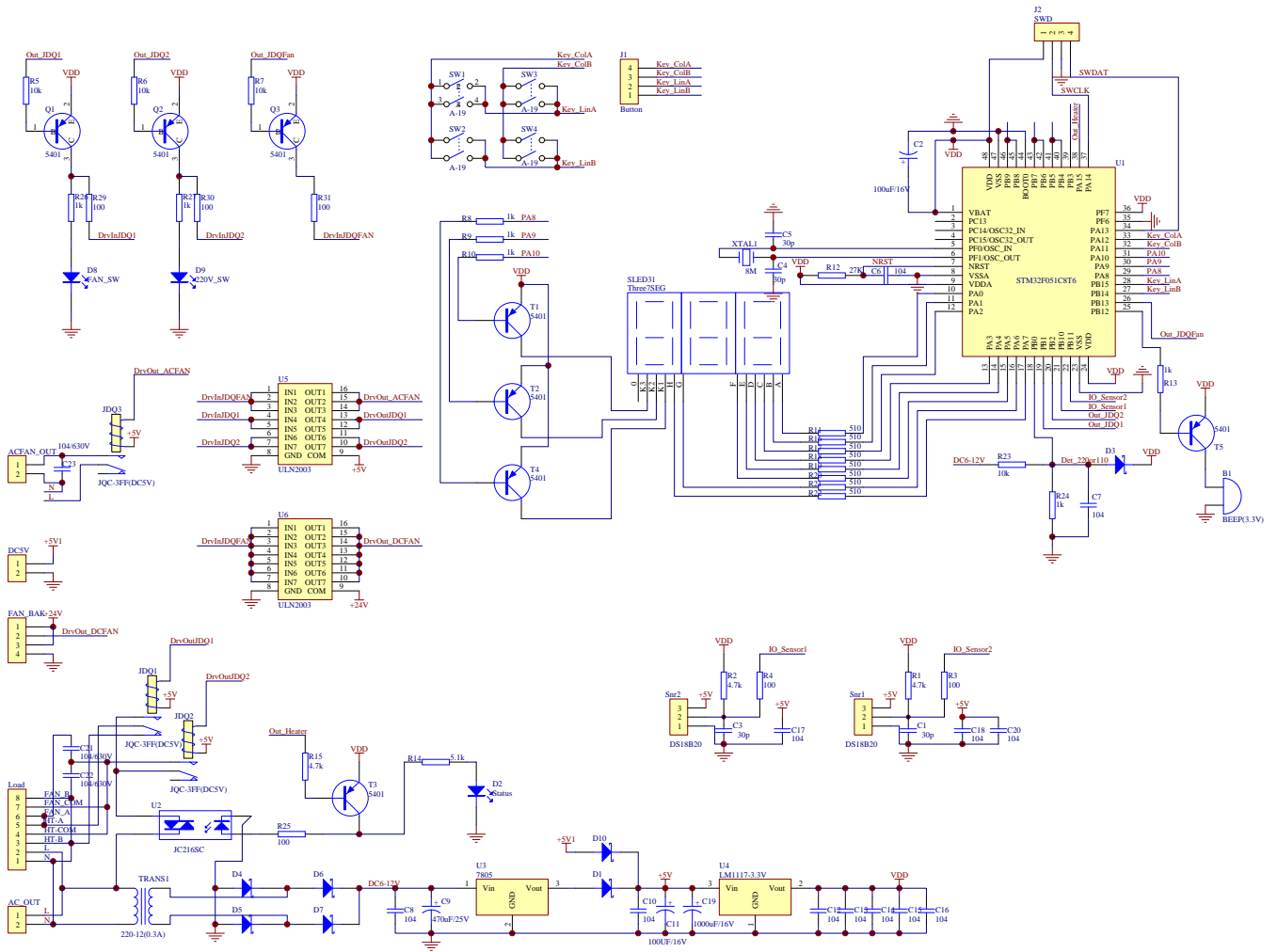

8. Maintenance Manual

- ① Prior to operation ,Please earnestly read this operation manual and carry out by this manual .
- ② Keep the instrument cleaning . Please clean up the remaining substance and dirt after work finished .

Standard Accessories List

No	Accessory name	Qty	Notes
1	Oven	1unit	
2	Power Cord	1pc	
3	Fuse	2pcs	
4	Operation Manual	1pc	

Published by:

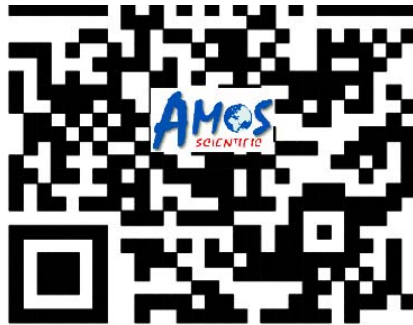

AMOS SCIENTIFIC PTY.LTD

37/632 CLAYTON ROAD , CLAYTON SOUTH VIC 3169 , AUSTRALIA

Tel: +61-3-95518850 Fax: +61-3-95516885

ABN 37 159 778 140

www.amos-scientific.com