

ASD220

Slide Dryer

Operation Manual

AMOS SCIENTIFIC PTY.LTD. ABN37 159 778 140

www.amos-scientific.com

Foreword

Thank you for purchasing our ASD220 Slide Dryer. This operation manual introduces product function, application method and matters need attention for safety. Please read in detail before operation to facilitate your better understanding of product performance and full utilization of each function. For any questions, please contact us and we provide satisfactory service at any time.

After completion of reading, please keep the manual properly for later reference.









Contents

1.Safety Instruction.....	1
1.1、 Safety Matters.....	1
1.2、 Conditions of Installation.....	1
1.3、 Delivery Inspection	1
2.Performance Features & Range of Application	2
3.Main Structure	2
4. Technical Parameters.....	2
5.Operation	3
5.1、 Keypad Description & Function	3
5.2、 Operation.....	3
5.3、 Alarm Function:	3
6. Layout Of Components & Electric Wiring Diagram	4
7. Schematic Diagram	5
8. Cleaning & Maintenance.....	6
9. Trouble Shooting.....	6

1. Safety Instruction

1.1、 Safety Matters

Please read these concise rules. Any violation against them will affect normal use of equipment or cause damage to equipment or danger.

-  Please use 220V±10% , 50Hz or 110V±10% , 60Hz AC..
-  Input power supply must be of good earth connection.
-  Keep away from flammables and explosives.
-  Don't open equipment without authorization to avoid high voltage shock.
-  Only professional maintenance personnel is allowed to repair equipment.
-  Use fuses with correct capacity.
-  Ensure power socket and circuit be able to bear 2 times of rated current at least.
-  Keep away from from any interference source.

- **Electrical Protection Ratings: I class, B type**
- **Shell protection grade: IP53**
- **Harmful liquid Leak-in proof degree: Normal (enclosed equipment without liquid leak-in proof)**
- **Working system: Continuous operation**

1.2、 Conditions of Installation

- Ensure more than 20cm of space around the equipment for heat dissipation.
- No water drop, steam, dust including oily dust and floating dust.
- No erosive, flammable and explosive gas and liquid.
- Solid and non-vibration.
- No interference from other electromagnetic signals.
- Operating ambient temperature from 5°C to 40°C, relative humidity under 90%

1.3、 Delivery Inspection

Product has been through strict inspection by quality management before ex-factory. However, product may be damaged or partially lost due to negligence or severe clash during delivery. Thus

1. Please check the contents inside including equipment, operation manual, packing list and spare parts after unpacking,

2. Check nameplate to ensure it is your order.
3. Make sure of no damage or loss during delivery.

2. Performance Features & Range of Application

ASD220 is a oblique-inserting slide dryer with slide inserted angle of 60° for the convenience of drying. Features are contactlessly controlled temperature, stable performance, fully programmed controlled system, easy and reliable operation. The purpose of equipment is to straighten, flatten and dry the sectioned tissue specimens.

3. Main Structure

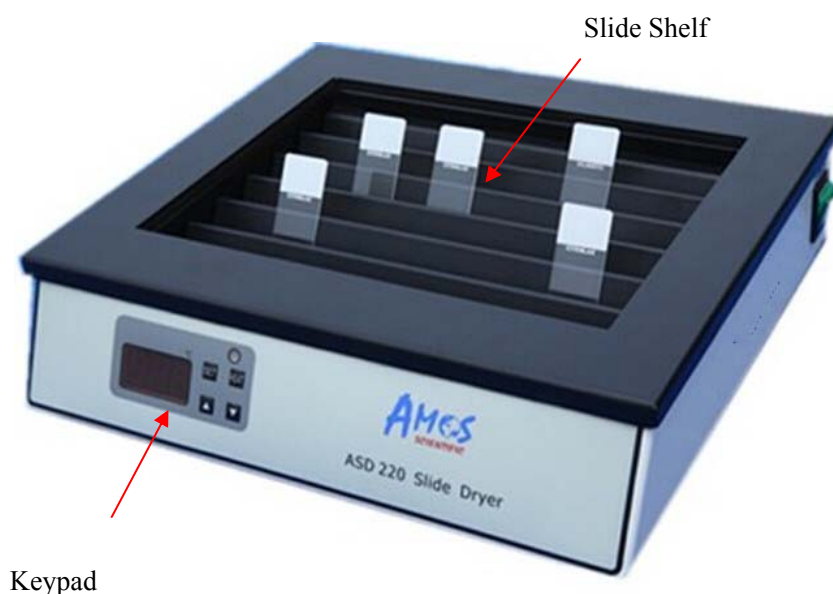

4. Technical Parameters

- Slide Capacity: 60 pieces max.
- Temperature Range: Ambient Temperature to 90°C
- Temperature Control Accuracy: $\pm 1^{\circ}\text{C}$
- Rated Voltage: 220V $\pm 10\%$ 50Hz (110V $\pm 10\%$ 60Hz)
- Fuse: 220V/3A (110V/5A)
- Rated Power: 330W
- External Dimensions (mm): 330 (W) \times 305 (D) \times 85(H)
- Weight: 2.75kg

5.Operation

5.1、 Keypad Description & Function

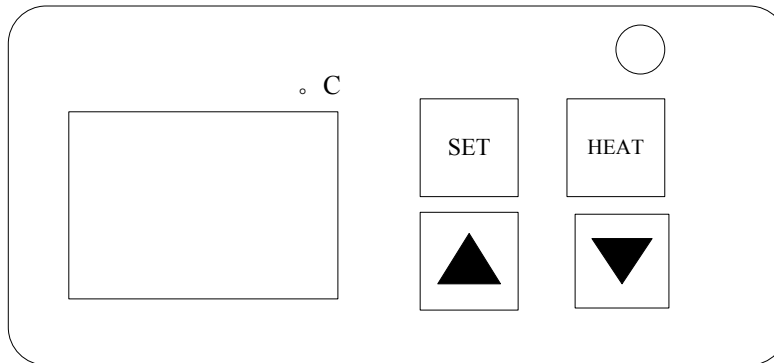

SET For temperature setting, press this button with single buzzing to indicate effective operation.

HEAT Press this button at red light indicated for heating on, and press again to stops heating.

▲ Set temperature. Press this button to increase temperature degree with single buzzing to indicate effective operation.

▼ Set temperature. Press this button to decrease temperature degree with single buzzing from buzzer to indicate effective operation.

5.2、 Operation

- Before operation, check if every part of equipment is in good condition.
- Plug in power and turn on the power switch at the side of equipment. If LED display is normal, system is under normal working state.
- Press **SET** to set temperature. **▲** **▼** are for adjusting temperature.
- Press **HEAT** to start heating.

Please turn off the power switch and plug out power after the working finished.

5.3、 Alarm Function:

Intermittent single buzzing from buzzer every 10 seconds indicates damage to digital sensor and no signal input. Thus sensor has to be changed.

6. Layout Of Components & Electric Wiring Diagram

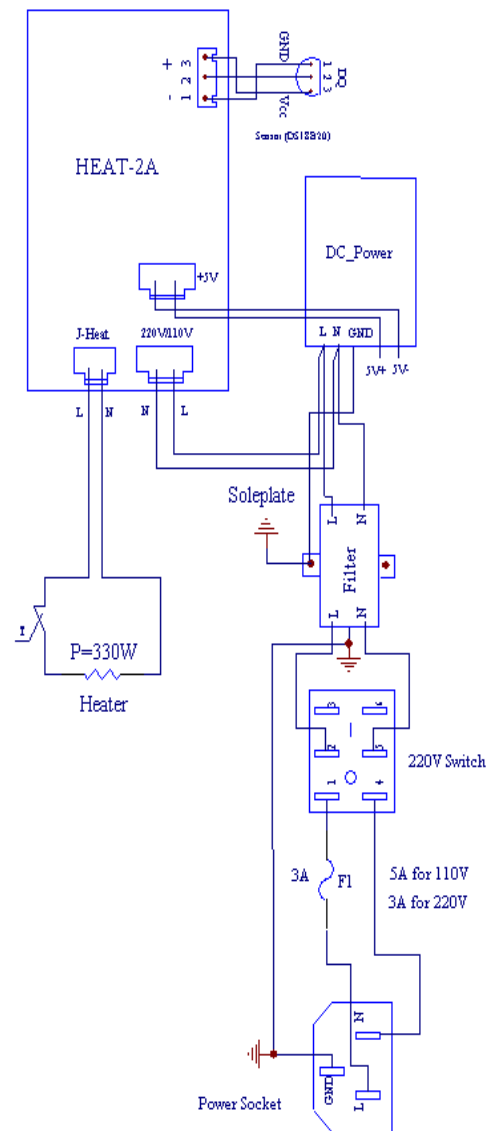
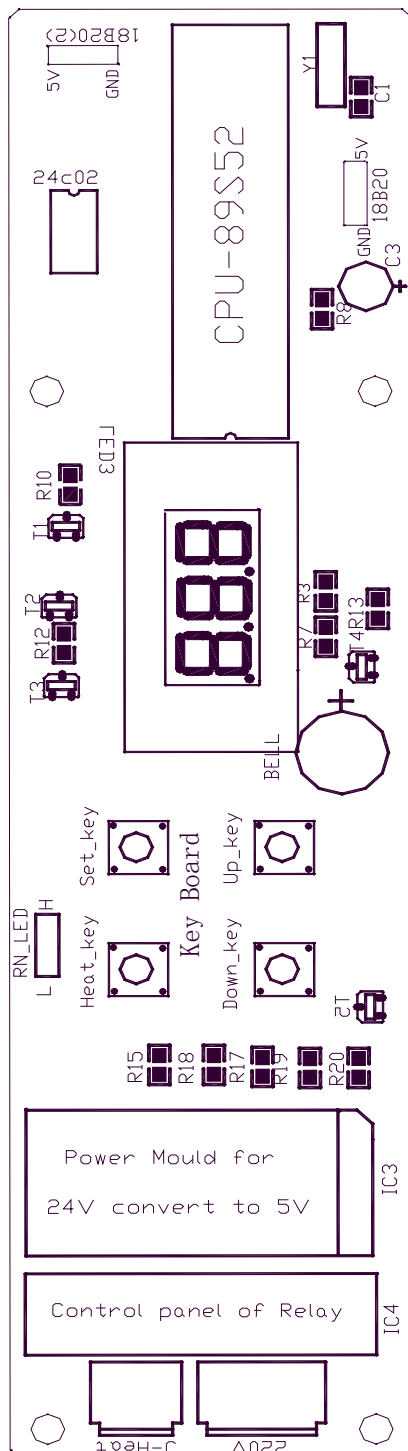

7. Schematic Diagram

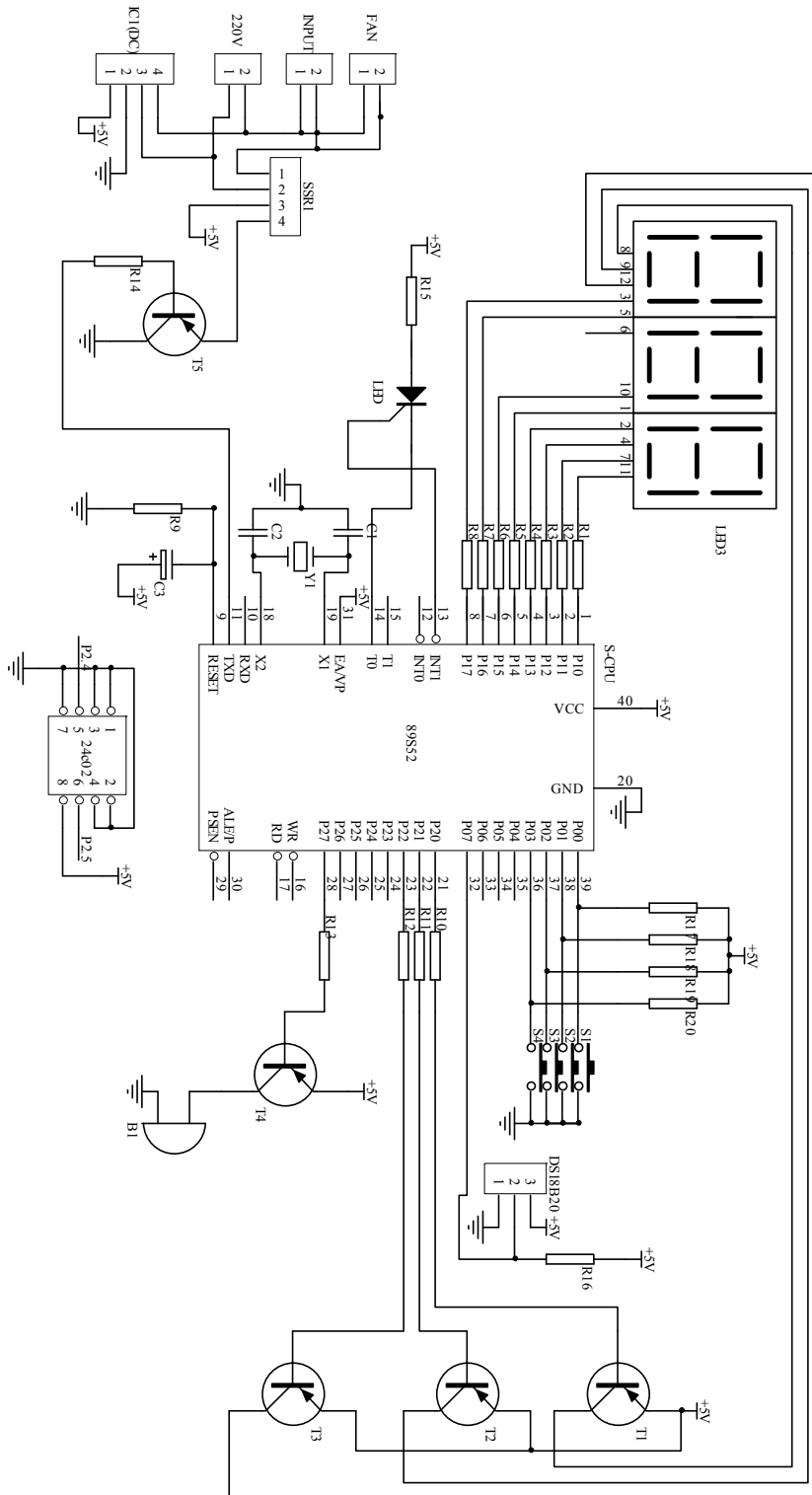

8. Cleaning & Maintenance

- Before operation, please carefully read product operation manual. Execute according to this manual requirements.
- Keep equipment clean. Clean the residuals and dirt after finish work
- It is not allowed to use sharp hard object to harm the worktable.
- Installation of fuse as Fig. 4.

Insert fuse(1) into installation part (2) and then insert whole installation part (2) into socket (3).

- Must plug out power before changing fuse.
- Specification of fuse: 3A (220V) ,5A(110V).



Fig. 4

9. Trouble Shooting

Problems		Possible Causes	Judgment Methods	Solutions
No display		Poor connection to power supply	Ensure connection to power supply	Ensure connection to power supply again.
		Power switch don't turned on.	Turn on power switch	Turn on
		Fuse blow	Take out the fuse to check its internal resistance by multimeter, if the value is infinite that means the fuse is broken	Change a new fuse.
Buzzer Alarm	E01 display	Sensor broken or heating film, solid state relay is damaged or disconnected		Change a new one element.
	E02 display	Digital sensor measures temperature is over 100 °C	Solid state relay or sensor broken.	Change a new solid state reply or fuse.
	E03 display	Digital sensor measures temperature is under -10 °C	Digital sensor is damaged	Change a new temperature sensor.

Standard Accessories List

No	Accessory Name	Qty	Notes
1	Slide Dryer	1 set	
2	Power Cord	1pc	
3	Fuse	2pcs	
4	Operation Manual	1pc	

Published by:

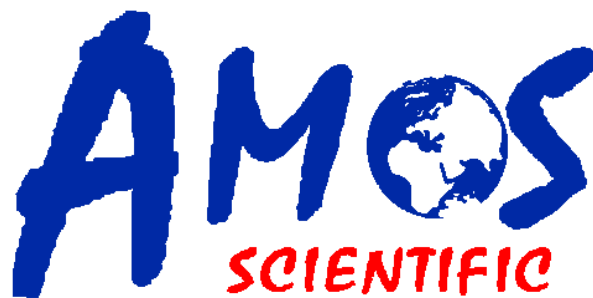

AMOS SCIENTIFIC PTY.LTD

7 Gabrielle Court, Bayswater North VIC 3153 Melbourne , Australia

Tel: +61-410190188 Fax: +61-410190188

ABN 37 159 778 140

www.amos-scientific.com