



**Cryostat Microtome Series**

**Service Manual**

## Foreward

This service manual is for Two Cryostat Microtome's repair and maintenance, which describes installation and maintenance of mechanical parts and electrical components testing in details . It is also can be used as training materials for internal maintenance staff.

As proprietary technical information , the service manual can not be transferred or leaked by the maintenance staff not from our company or authorized agent to any third party without our permission. Otherwise the person should be responsible for the all losses and bear legal liability .

With the development of technology and constantly updating of products , this manual will make the corresponding changes . If you find any product does not match with the manual service, please contact us .

# Contents

<b>1、 Functional principle and classification.....</b>	<b>1</b>
<b>2、 Structure.....</b>	<b>3</b>
<b>3、 Preparation work before maintenance.....</b>	<b>8</b>
3.1 Tools.....	8
3.2 Attention Matters.....	8
<b>4、 Installation and Maintenance instrument.....</b>	<b>8</b>
4.1 Knife Holder Ass'y installation.....	8
4.2 Advance parts Ass'y installation.....	14
4.3 Right handling wheel parts Ass'y installation.....	19
4.4 Stationary Heat Extractor Ass'y installation.....	21
4.5 Peltier & Sensor Ass'y installation.....	22
4.6 Chamber temperature sensor Ass'y installation.....	23
4.7 Specimen clamp peltier Ass'y installation.....	24
4.8 Fluorescent lamp & UV lamp Ass'y installation.....	25
4.9 Parameter regulation of driver for advance motor and section motor .....	26
4.10 Wiring diagram.....	26
<b>5、 Trouble shooting.....</b>	<b>27</b>
<b>6、 Clearance and Maintenance.....</b>	<b>30</b>
6.1 Cleaning the instrument.....	30
6.2 Maintenance.....	31

# 1、 Functional principle and classification

On basis of rotary automatic microtome add refrigeration components to become the current Cryostat microtome which shorten diagnosis time greatly and makes it easier and more precise to section .

## Fully-automatic Cryostat Microtome AST 550

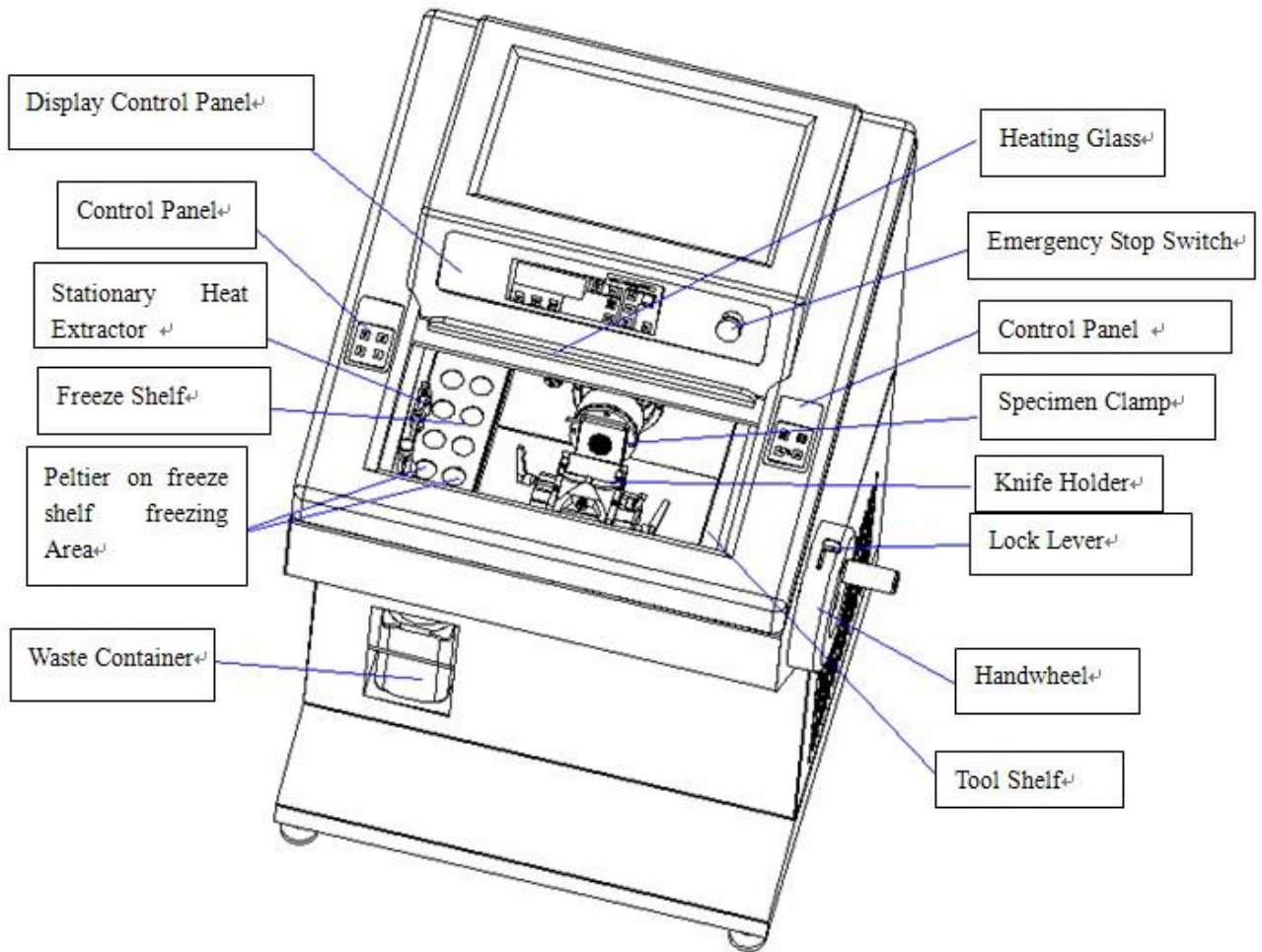

## Semi-automatic Cryostat Microtome AST 500

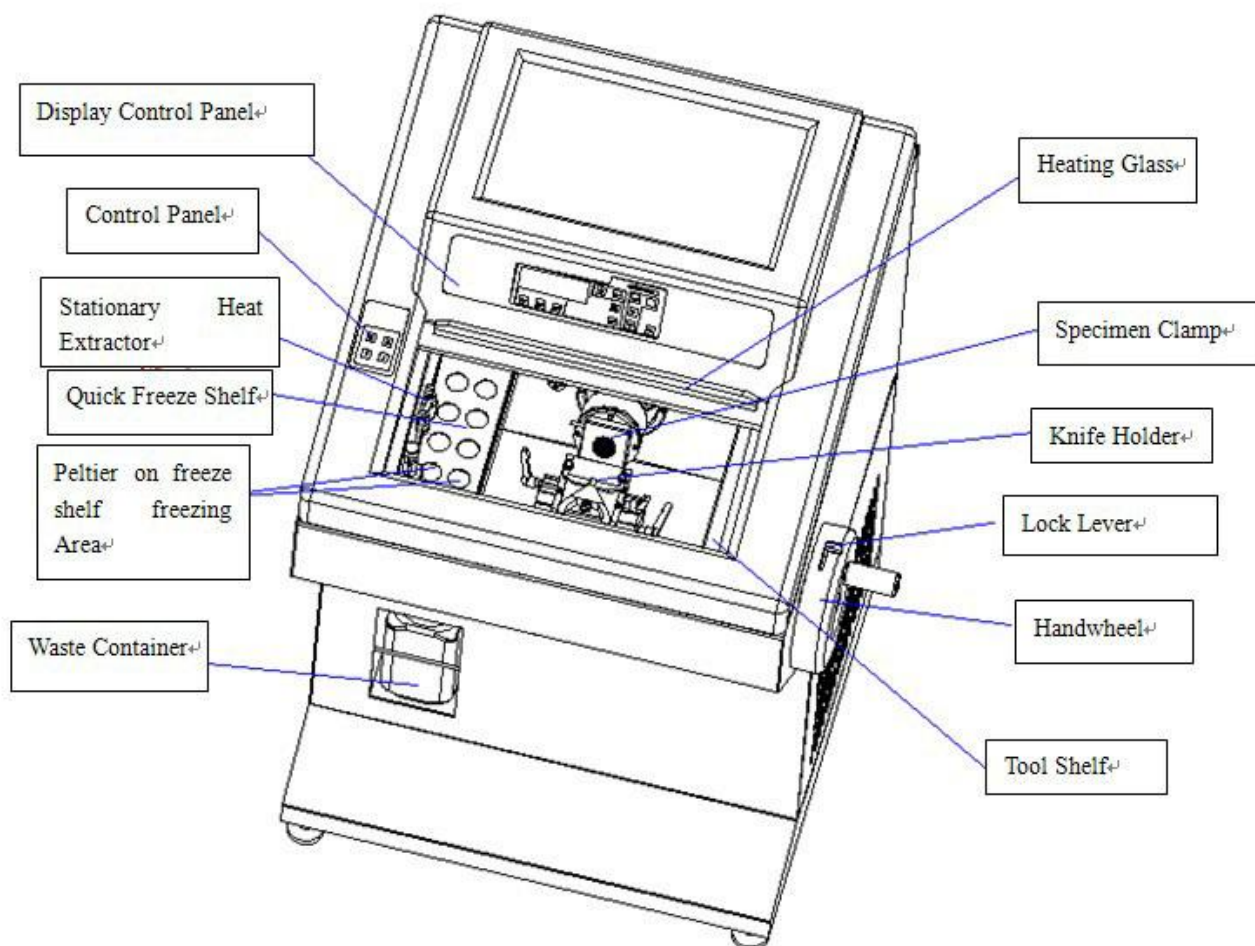

There are two models as different functions, AST500semi-automatic cryostat microtome, AST550 fully automatic cryostat microtome. Its different function as bellows:

	Fully-automatic operation	Emergency-stop Switch
AST500	X	X
AST550	√	√

## 2、 Structure:

The cryostat microtome includes the following parts: Instrument base Ass'y, knife holder Ass'y, Clamp holder Ass'y, Feed Ass'y, Right handling wheel Ass'y, Master control panel Ass'y, Display board Ass'y, Freezing shelf Ass'y, Stationary heat extractor Ass'y, O<sub>3</sub>disinfection Ass'y, Refrigeration Ass'y, housing Ass'y and others parts. The structure of its function as picture shows:



①、 **Instrument base Ass'y:** Its function is a carrier for all components .



②、 **Knife holder Ass'y:** Its function is to ensure the blades could be stable clamped.

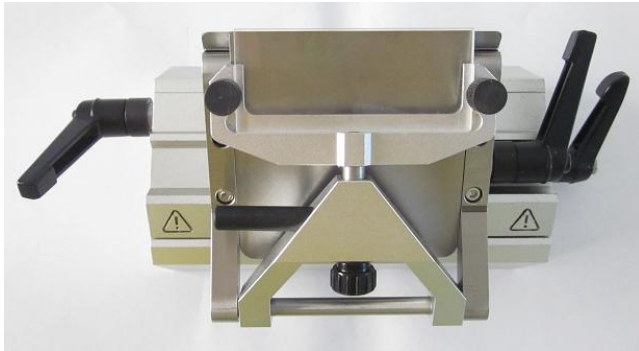

③、 **Clamp holder Ass'y:** Its function is to ensure the specimen could be stable fixed.



④、 **Stationary heat extractor Ass'y:** Its function is to adjust the specimen's horizontal and vertical angle.

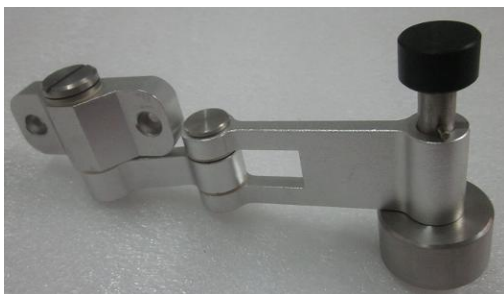

⑤、 **Feed Ass'y:** It is the central parts which function is control the specimen vertical movement and tissue feed.



AST 500

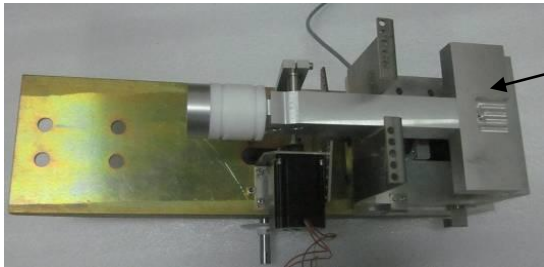

AST 500

⑥、 **Master control board Ass'y:** It is the program control center





- ⑦、 **Right handling wheel Ass'y:** Its function is to make specimen vertical movement inertia convert into rotating movement inertia, ensure the specimen move easily and stability.

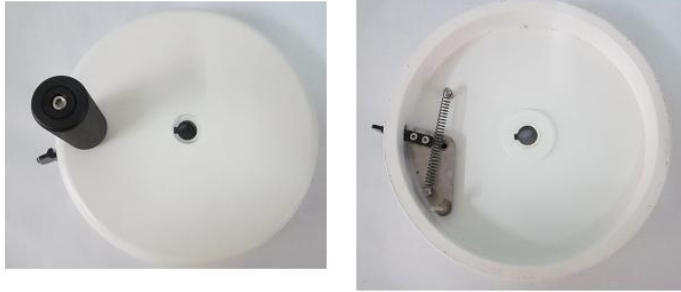

- ⑧、 **Refrigeration Ass'y:** Its function is to freeze the chamber .



- ⑨、 **Display&Control Ass'y:** It used to displaying and setting of the parameter .



⑩、 O3 disinfection Ass'y: It is used to disinfect the whole chamber



⑪、 Connection board Ass'y: Its function is responsible for the power and others input connection.



## 3、 Preparation work before maintenance

### 3.1 Tools

Arrange the relative tools before maintenance, it includes:

- \* Allen wrench( include 2.5、 3、 4、 5 five kinds )
- \* Phillips screwdriver (large and small two kinds)
- \* Slotted screwdriver (large and small two kinds)
- \*Pinchers ( includes: pliers, long nosed pliers, circlip pliers, diagonal cutting plier, Strippers )
- \*Fork Spanner(includes 5.5、 7、 8、 10 four kinds)
- \*Small adjustable spanner
- \*Hammer
- \*Forceps
- \*Spring disassembly tools ( includes 2、 2.5、 3 three kinds )
- \*Torque screwdriver ( includes:1-15n and100-500n torque two kinds, and its relative allen wrench 2、 3 two kinds )
- \* Multimeter
- \* Soldering Iron

### 3.2 Attention Matter

- ①、 Don't do any electrical work during maintenance , in order to avoid electrocuted accidentally.
- ②、 Please take off the blades to the safety place and remove the blade holder before maintenance.
- ③、 Please make sure the handwheel is locking before maintenance.
- ④、 Use Multimeter and soldering Iron correctly during the maintenance, specially during the electrified testing , in order to avoid the electrical components damage caused by short circuit .
- ⑤、 Please make sure the guide rail, lead screw and others movement parts must be cleaning to extend their life and precise.
- ⑥、 Don't let any liquid into the instrument during the machine cleaning and maintenance.

## 4、 Installation and Maintenance instrument

### 4.1 Mechanical parts installation

#### 4.1 Knife holder Ass'y installation

- 、 Y axis slider and rail( $\varnothing$  3x 14Spring pins, round type ) The spring pins MUST exposed length of 4mm higher than Y axis slider.



- 、 Axis sleeve Two axis sleeves must be very tight fit to install on the bottom

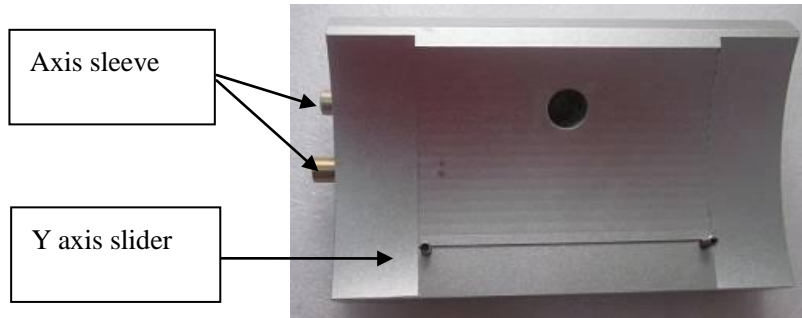

●、Lock pillar 4 and lock set 4 ( Disc Spring、M4X6 sunk screws) The number of disc springs be used to calibration, cannot exactly confirm .

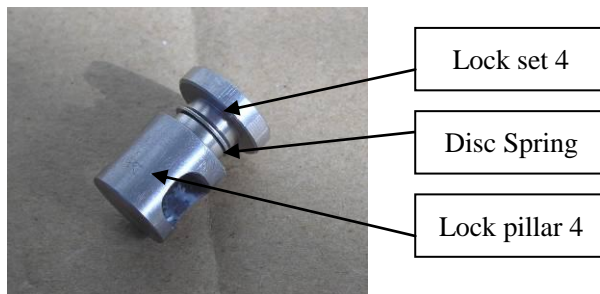

●、 Lock pillar 4 accessory、 pressure spring. Note: Lubricate grease on the connection of lock pillar and other parts , to make the lever rotation flexible.

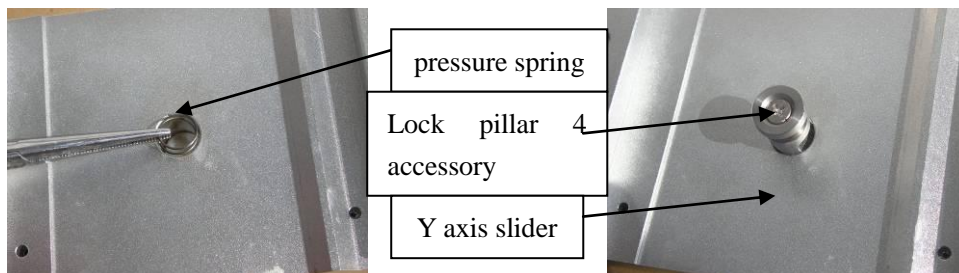

●、 Lock lever 2、 Z axis slider (M3x8 inner hexagon screw) Note: Pay attention to adjust the number of disc spring on the Lock Pillar 4, control rotation angel range of the lock lever 2 rotating clockwise and counter-clockwise during on 260-280 degrees and flexible rotating . Lubricate grease on any connection parts. After finishing the adjustment, please take down the Z-axis slider. By the way , the screw is just to prevent axial movement of the lock lever 2, which cannot affect the rotation.

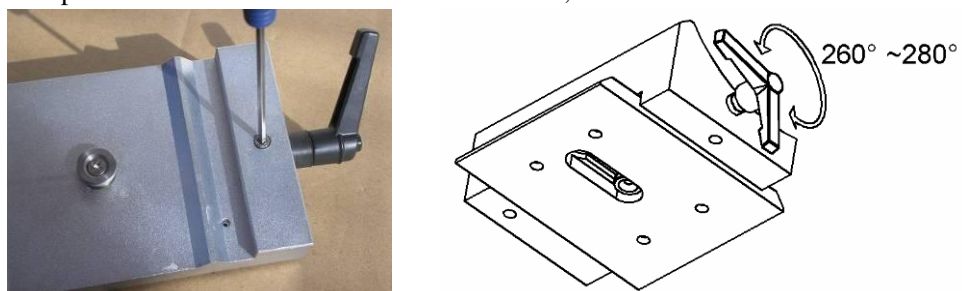

- **Lock pillar 3 and lock set 3** (Disc spring, M5x8 sunk screw) The number of disc springs which be used to calibration cannot exactly confirm .

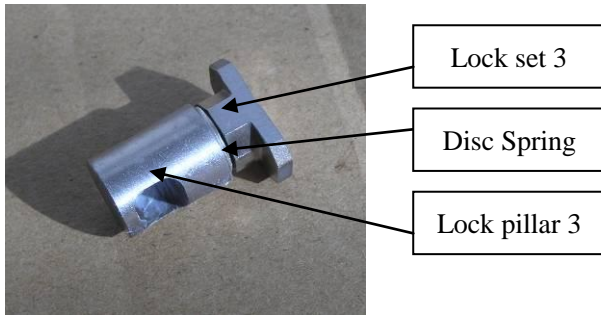

- **Lock pillar 3 accessory, pressure spring, Lock lever 2, X-axis slider** (M3x8 inner hexagon screw) Note: Pay attention to adjust the number of disc spring on the Lock Pillar 3, control rotation angel range of the lock lever 2 rotating clockwise and counter-clockwise during on 260-280 degrees and flexible rotating . Lubricate grease on any connection parts. After finish the adjustment, please take down the X-axis slider. BTW, the screw just prevent movement of the lock lever 2, which cannot affect the rotation.

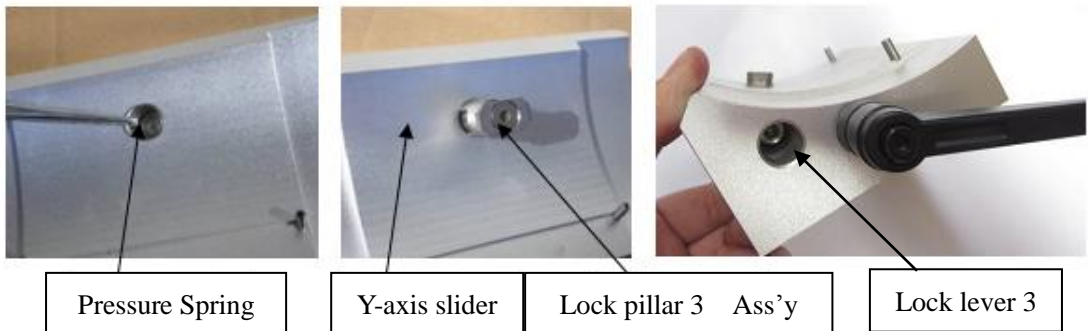

- **X-axis and axis sleeve.** Must be very tight fit to install on the bottom

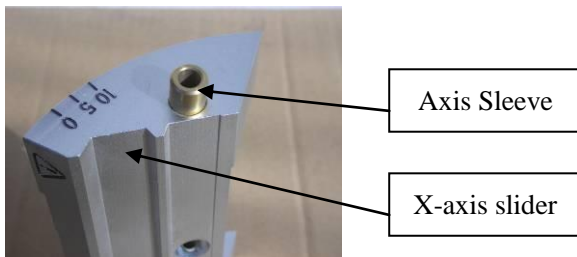

- **Lock pillar 2, Pressure spring.** Note: Lubricate grease on the parts of connection with lock pillar 2, to make the lever rotation flexible.

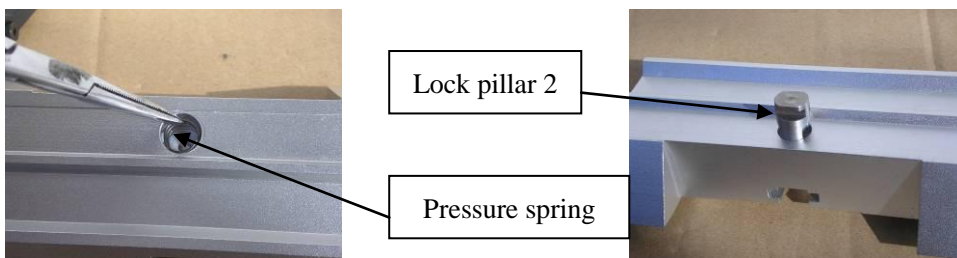

- **Lock pillar 2** (M3x8 inner hexagon screw) Note: Lubricate grease on the parts of connection

with lock pillar 2, to make the lever rotation flexible. The screw prevents movement of the lock lever 2, which cannot affect the rotation.

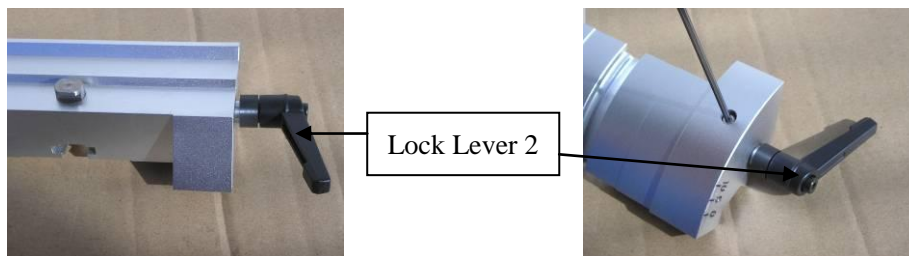

●、X-axis slider Ass'y and Y-axis slider Ass'y



●、Clamp 2, hinges, Lever for Hinges, Clamp 1 (M3x8 inner hexagon screw) Note: Pay attention to adjust the Clamp 2 and hinges, to ensure the cutting edge of clamp 1 and clamp 2 parallel and aligned.

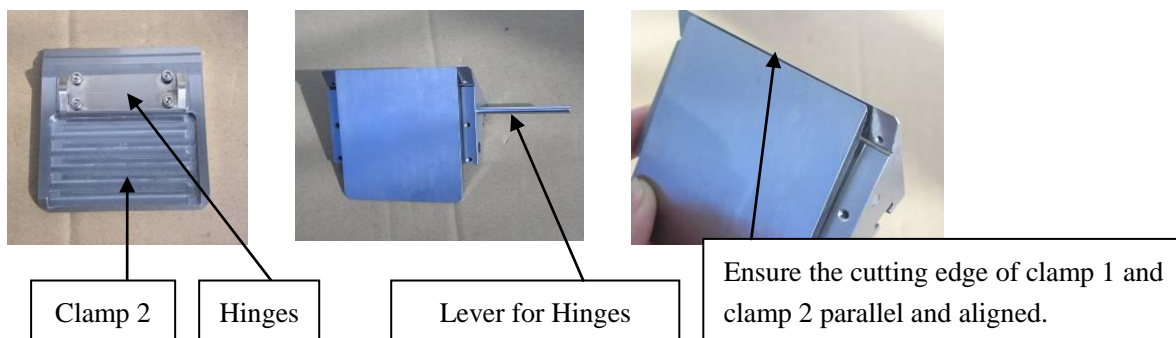

●、Lock Pillar 1, Lock Lever 1 (Disc Spring, M3x6 sunk screw) Note: Lubricate grease on the parts of connection with lock pillar 1.

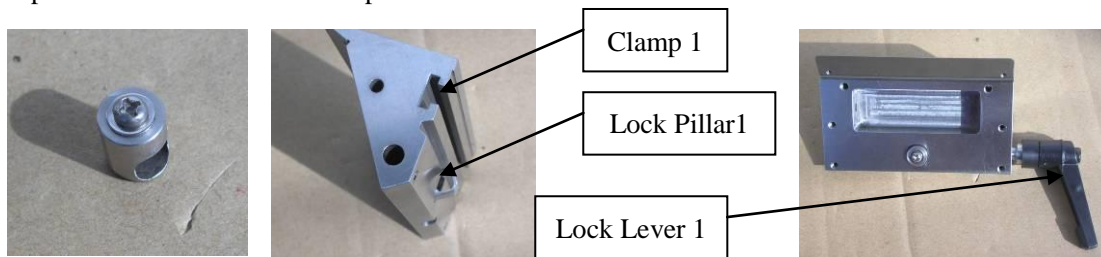

●、Calibration and Fix (M3x4 sunk screw) Note: Pay attention to adjust the number of disc spring on the Lock Pillar 1, make sure the lock lever 1 rotating one cycle along Max gap is 1mm max. The screw is just to prevent movement of the lock lever 1, which cannot affect the rotation.

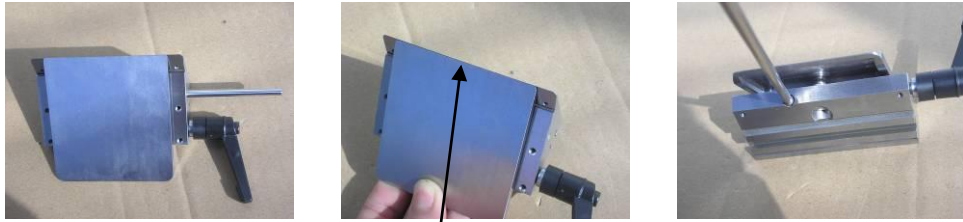

Rotate lock lever 1 one cycle along gap is 1mm max.

- **Blade pad** (M2x4 sunk screw、M4x10 Ball slotted set screws) Note: The blade pad don't need to install for High profile disposable blade. After finished the M4x10 Ball slotted set screws installation that must to ensure the process of lock lever 1 rotating one cycle, the ball bearing should always against the clamp 2 and can't fully retract into screw.



Blade pad

Ball slotted set screws

- Twist the lever of anti-roll plate into anti-roll plate and then cover it with lever sleeve ; Fix the hinge in the middle of anti-roll base , then fix the two supports on each sides with Inner hexagon screws by M3×10

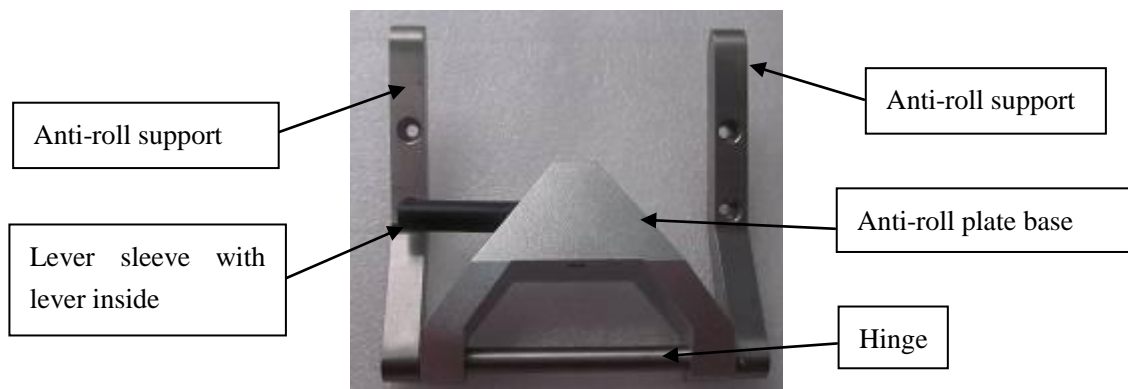

- Twist the anti-roll fixed axis into the plate , then position the anti-roll plate into fixed board with M3 bolt , left M3 bolt and butterfly spring . Notices: The quantity of disc spring can not be confirmed just used to adjust .

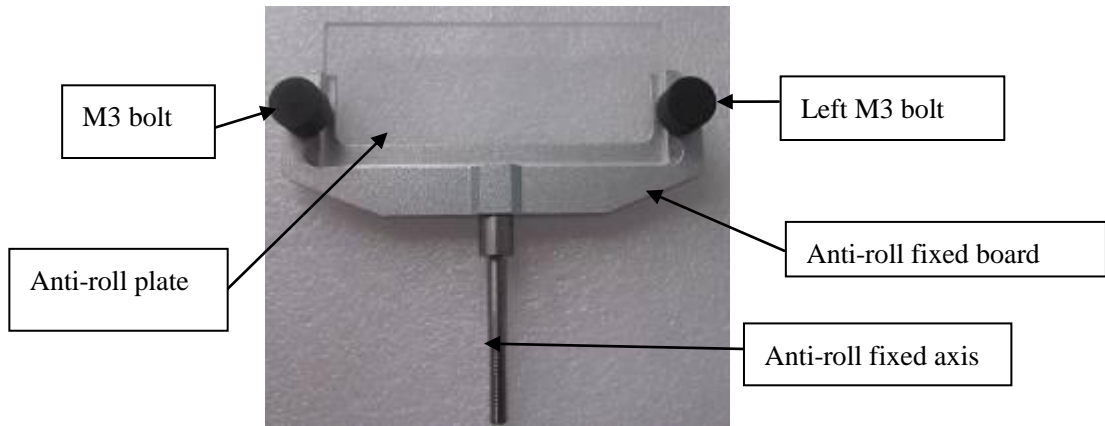

●、Fix the anti-roll plate base ass'y on knife clamp 1 ass'y with M3 × 10inner hexagon screws(4pcs) , then knife clamp 1 will be fixed on X axis slider . Notices : The anti-roll plate board should turn over flexible .

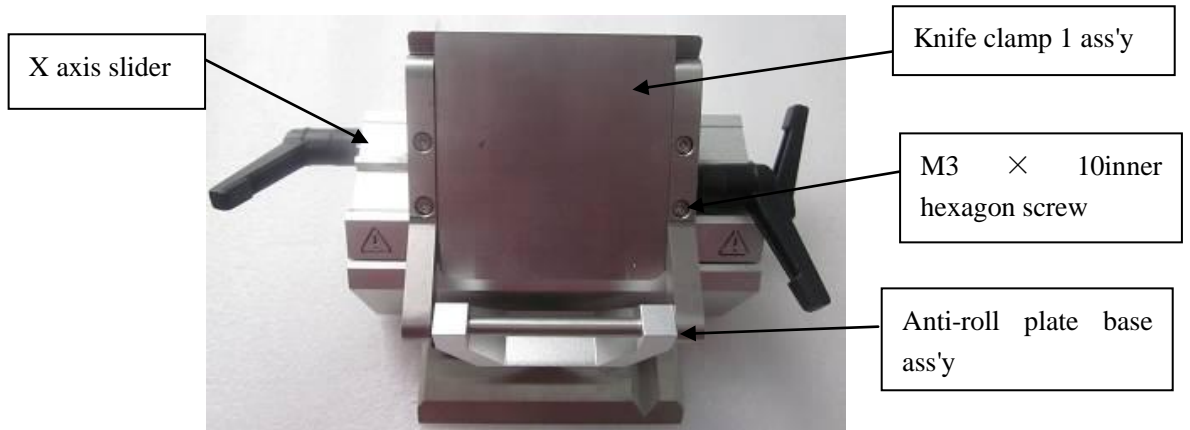

●、Fix the anti-roll plate ass'y into anti-roll base with disc spring inside by straight grain knob . Attention : Adjust the straight grain to ensure anti-roll plate move up and down smoothly .

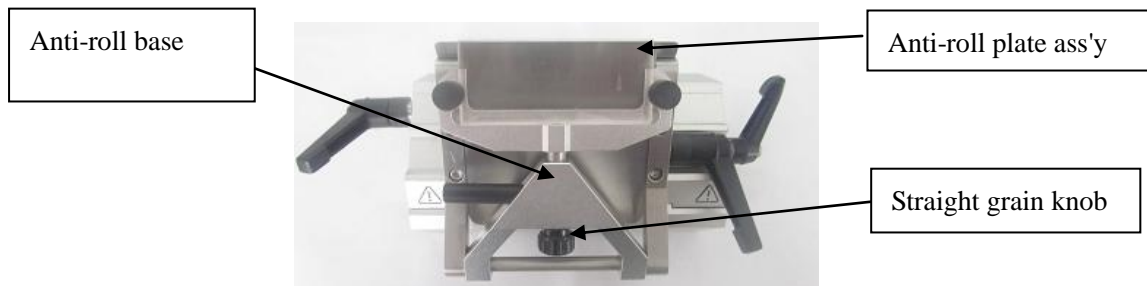



#### 4.2 Advance feed Ass'y installation

●、Tighten right A guide rail and left A guide on the slider slightly with M4×20inner hexagon screw(8 pcs) , finally use torque screwdriver to tighten. Strength is about 150N, and order is from middle to sides.

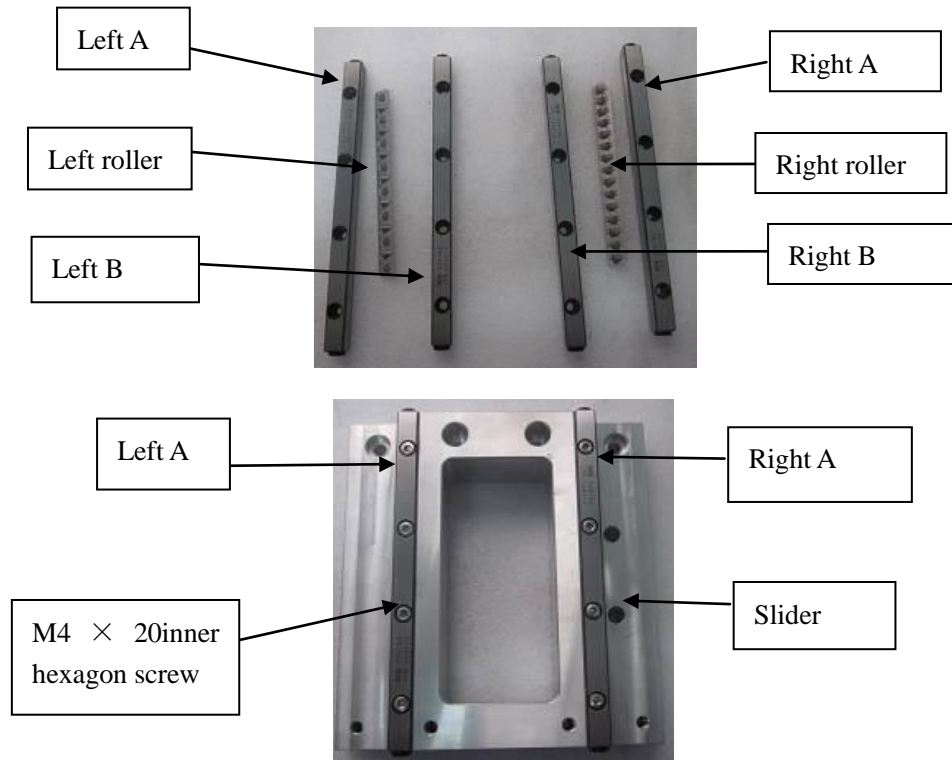

●、Tighten left B and right B on support base 1 with M4×20inner hexagon screw(8pcs) slightly , finally use torque screwdriver to tighten. Strength is about 150N .

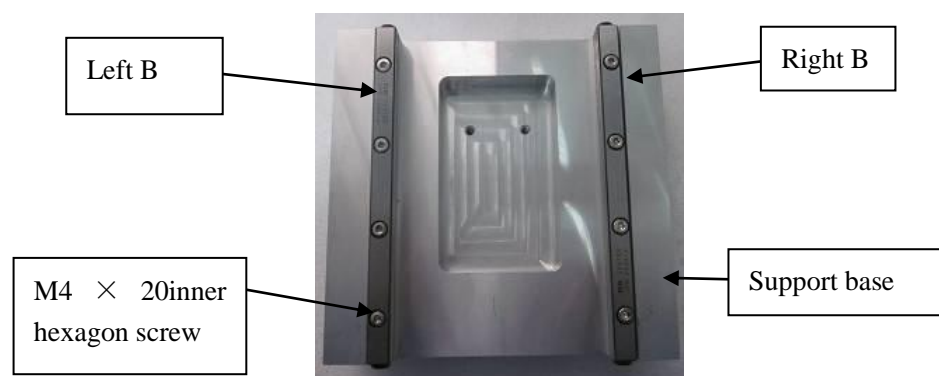

●、Install the slider and hinge block A together with M6×25inner hexagon screws(4pcs).

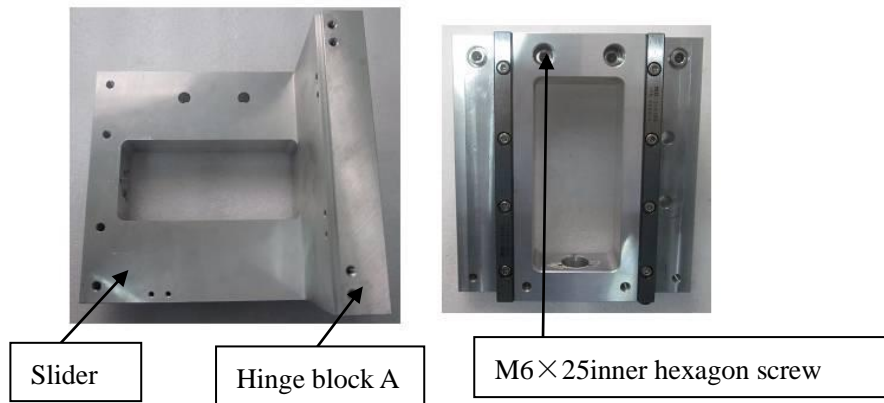

●、 Fix the support base ass'y and slider ass'y together and remove the screws on right guide rail A and right rail B . Insert the left roller and right roller in order , and screw on the two removed screw , tighten slightly 4 M4×25 inner hexagon set screw , then cover 4 nuts . Push the slider to make the roller between the up screw on right A guide rail and down screw on right B guide rail , and use torque screwdriver with 15N to tighten these screws . The operation order is :

- a. Move the slider to the uppermost position and tighten the two screws on the uppermost and upper position .
- b. Move the slider to downmost position and tighten the two screws on the downmost and downer position .

After finishing the above steps, use torque screwdriver with 150N to tighten the screw on right B , tighten the M4 nuts , at last lubricate grease on the guide roller.



Screw



Left roller

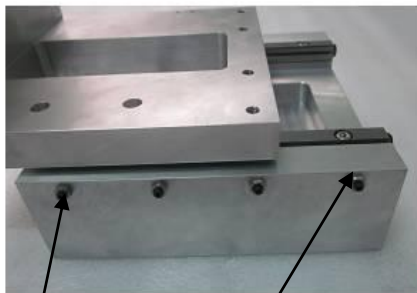

Set screw

M4 nut

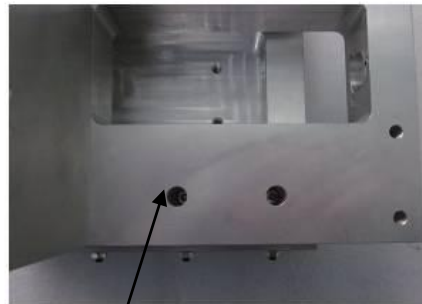

150N Bending moment

- 、 Install the advance feed motor on the motor block and fasten it by 4 pieces of M3×16inner hexagon screw and 4 pieces of spring washer . The motor wire should be fixed by 2 pieces of M3×14 inner hexagon screw and cable chip . Please pay attention to the wire installation direction .

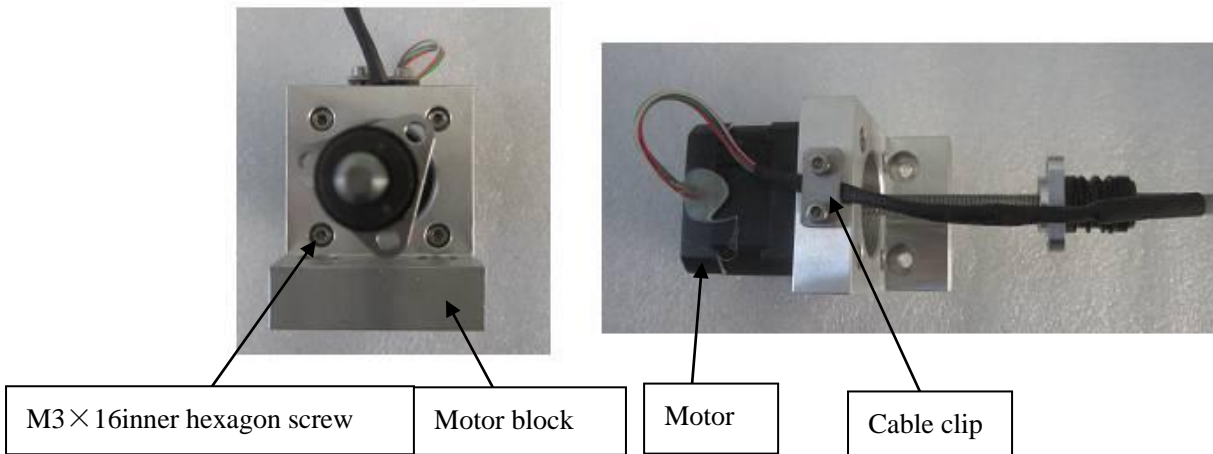

- 、 Install the motor ass'y on to support base ass'y by 3 pieces of M3×10 inner hexagon screw and 2 pieces of M3×20 inner hexagon screw . Then fix the limit board A and limit board B on the slider block separately by 4 pieces of M3×8 inner hexagon screw .

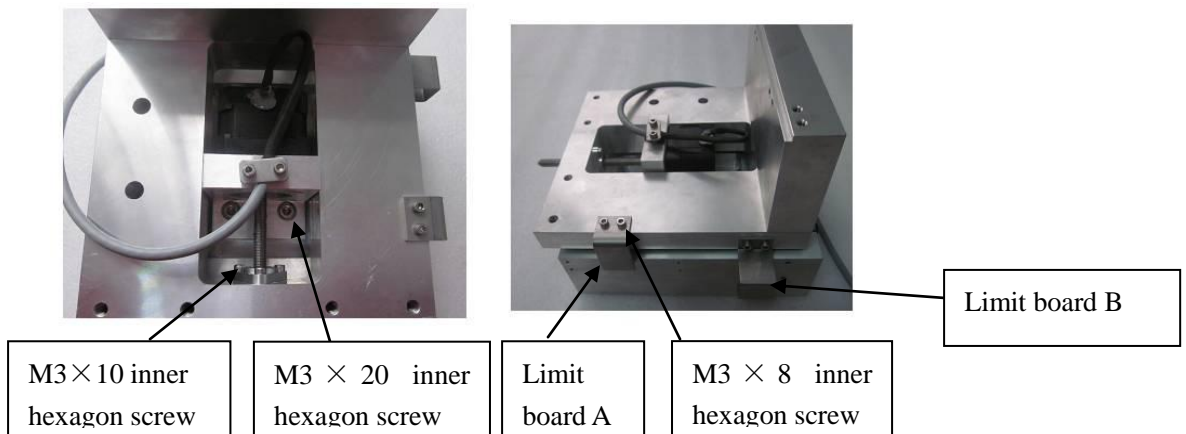

- 、 Install the front limit switch and back limit switch on support base , and fasten them by 4 pieces of M2×12 cross blot ; Then fasten the zero-position optoelectronic switch on the support base by 2 pieces of M3×16inner hexagon screw .

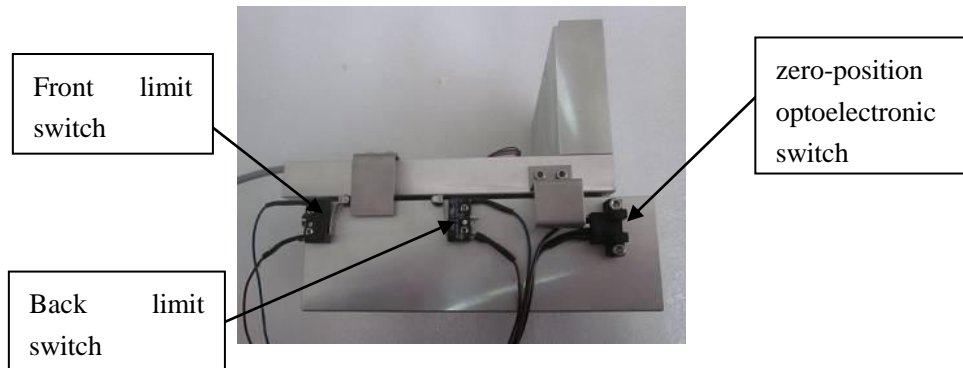

- 、 Install the hinge ( 2 pieces ) and pinch plate ( 2 pieces ) on the hinge block by M4×10inner hexagon screw ( 4 pieces ) .

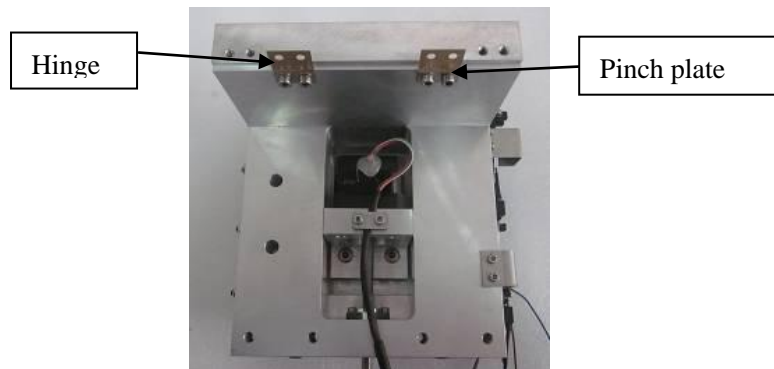

- 、 Install the spring fixed board A on the slider block by M6×12inner hexagon screw ( 4 pieces ) .

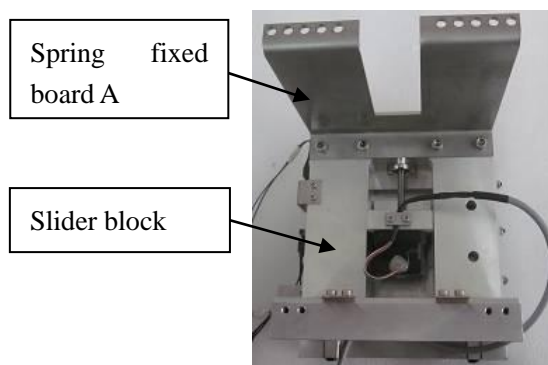

- 、Install hinge block B together with cutting stick with M5×20inner hexagon screw ( 2 pieces ) and M5×30inner hexagon screw fastened .

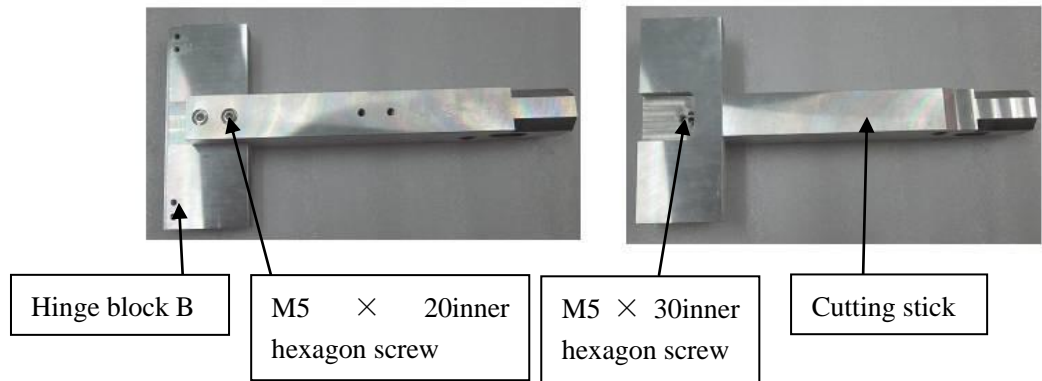

- 、Install the heating-insulating block and connection block on the cutting stick with M4 × 25inner hexagon screw ( 2 pieces) fastened .

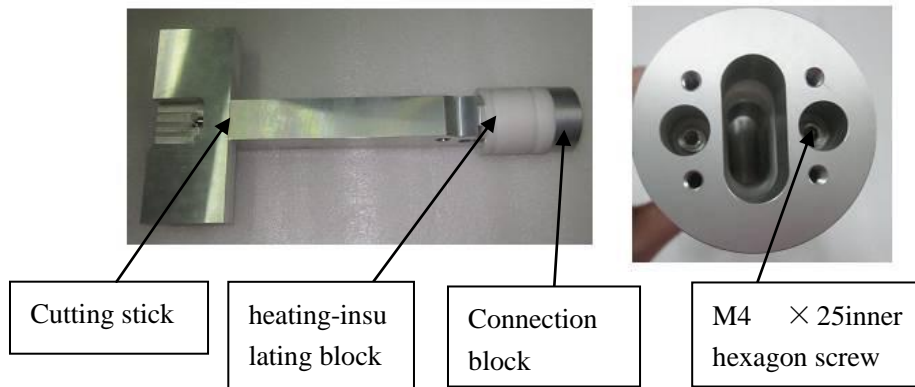

- 、Install spring fixed board on the cutting stick with M5×12inner hexagon screw ( 2 pieces) fastened .

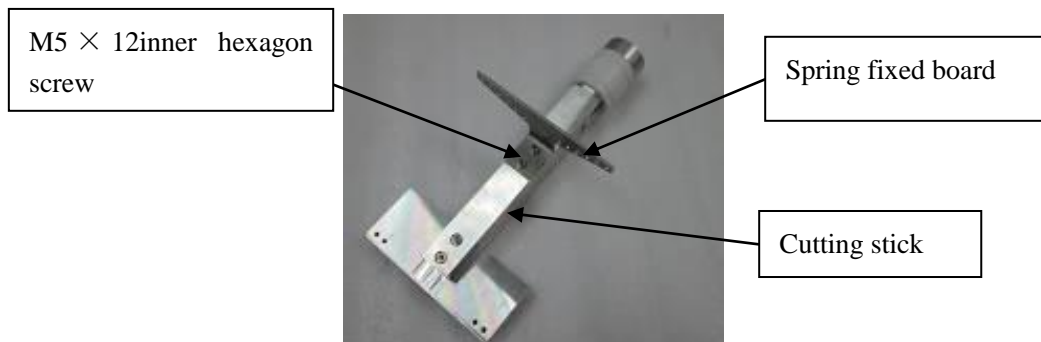

- 、Install the hinge ( 2 pieces) and pinch plate on the hinge block B with M4×10inner hexagon screw ( 2 pieces) fastened .

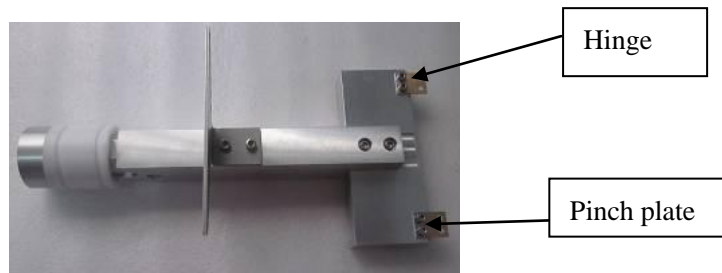

- 、 Install the connecting lever A into cutting stick with M5×16inner hexagon screw and washer fastened .

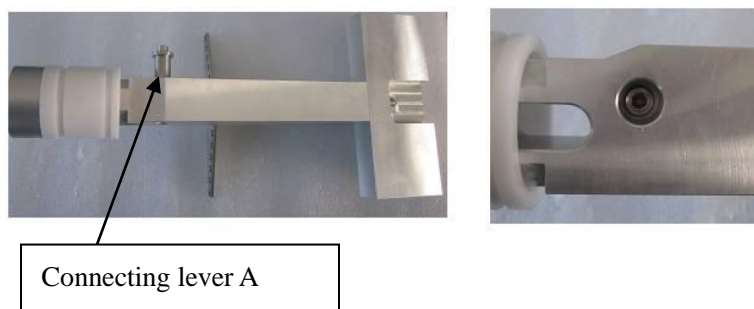

- 、 Install the cutting stick ass'y together with the support base ass'y with hinges pressed by connecting pinch plate ( 4 pieces ) , then fasten them by M4×10inner hexagon screw ( 8 pieces) . Attention : Hinge block 1 and hinge block 2 should be parallel .

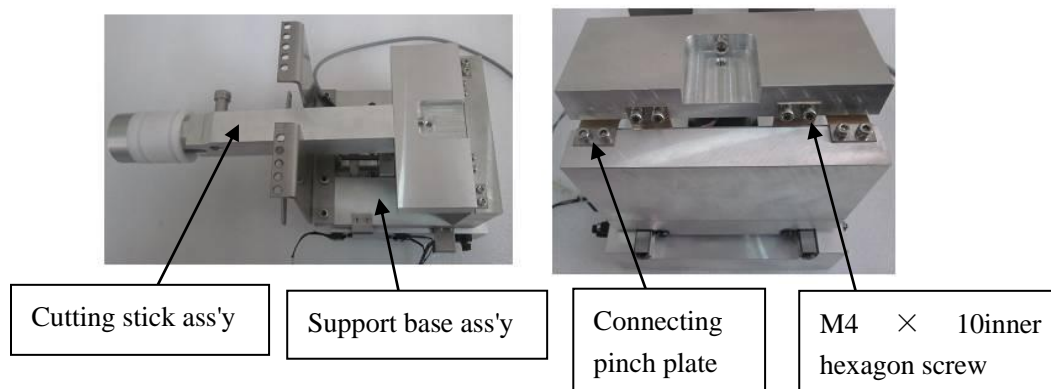

### 4.3 Right handwheel Ass'y installation

- 、 First twist the bolt 4 in the right handwheel ; Then press the stop sleeve in the handwheel .  
Attention : Please ensure the stop sleeve should be fit with the handwheel .

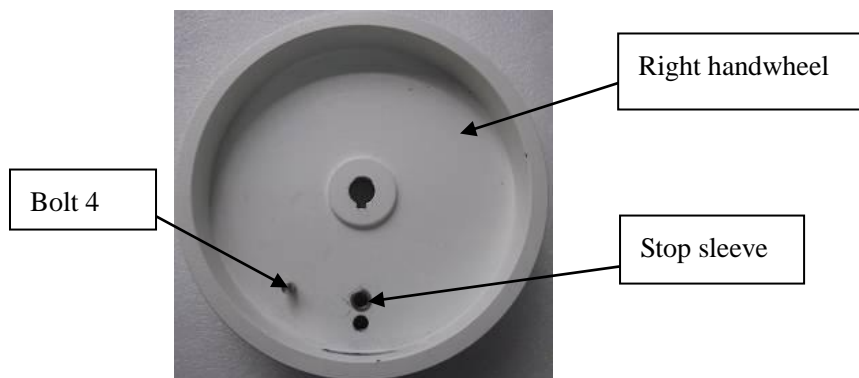

●、 Twist the bolt 5 in the stop clip .

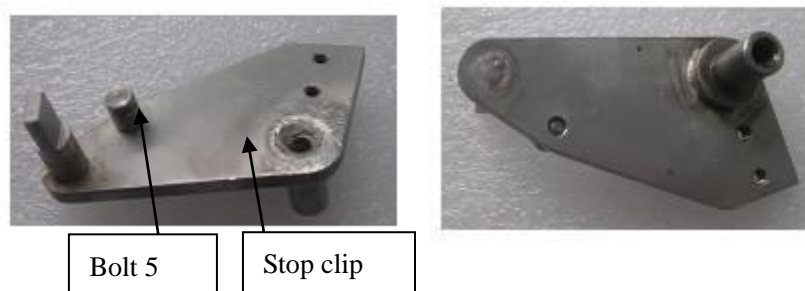

●、 Lubricate the contact surface between stop shaft and stop sleeve with grease , then fix the stop shaft in the stop sleeve with M3×8 inner hexagon screw ( 2 pieces ) fastened . And install bolt spring between bolt 4 and bolt 5 .

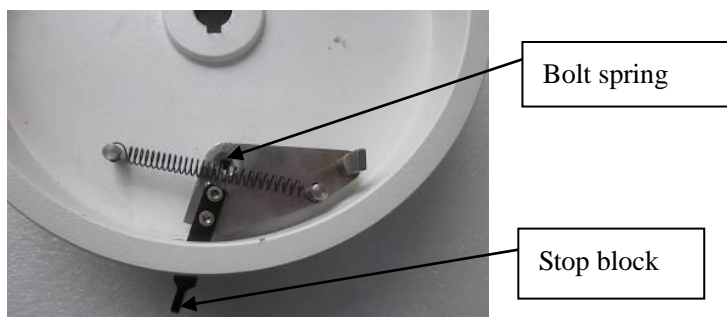

●、 Twist the handwheel axis into handwheel . Attention : the screw thread to be fixed .

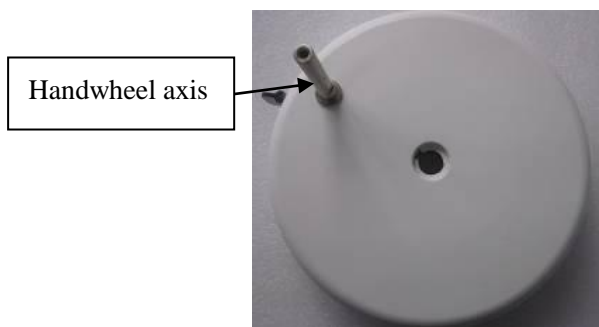

●、 Handle sleeve、 handle pad ( bearing、 M5x12 inner hexagon screw ) Ensure the sleeve could rotate flexibly during installation.

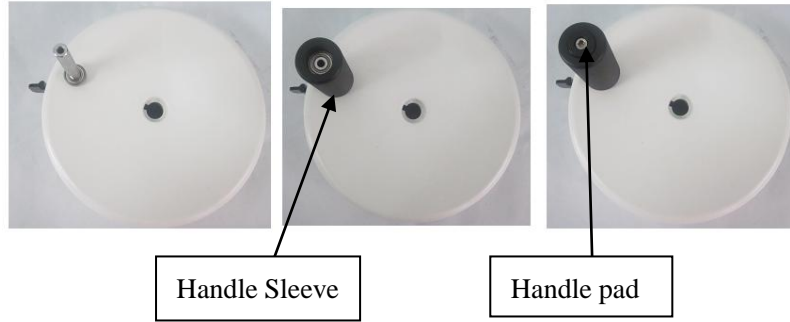

#### 4.4 Stationary heat extractor Ass'y installation .

- 、 Install the plastic lantern ring ( 2 pieces ) into stationary heat extractor shelf 1 as followed figure . Then install the stationary heat extractor shelf 2 , stationary heat extractor shelf 3 , disc spring , stationary heat extractor shelf 4 into stationary heat extractor shelf 1 in order , at last cover stationary heat extractor shelf 5 with M5×15 inner hexagon screw fastened . ( Note : The quantity of disc spring can not be confirmed just used to adjust . Install the plastic lantern ring ( 2 pieces ) and washer into stationary heat extractor shelf 5 separately .

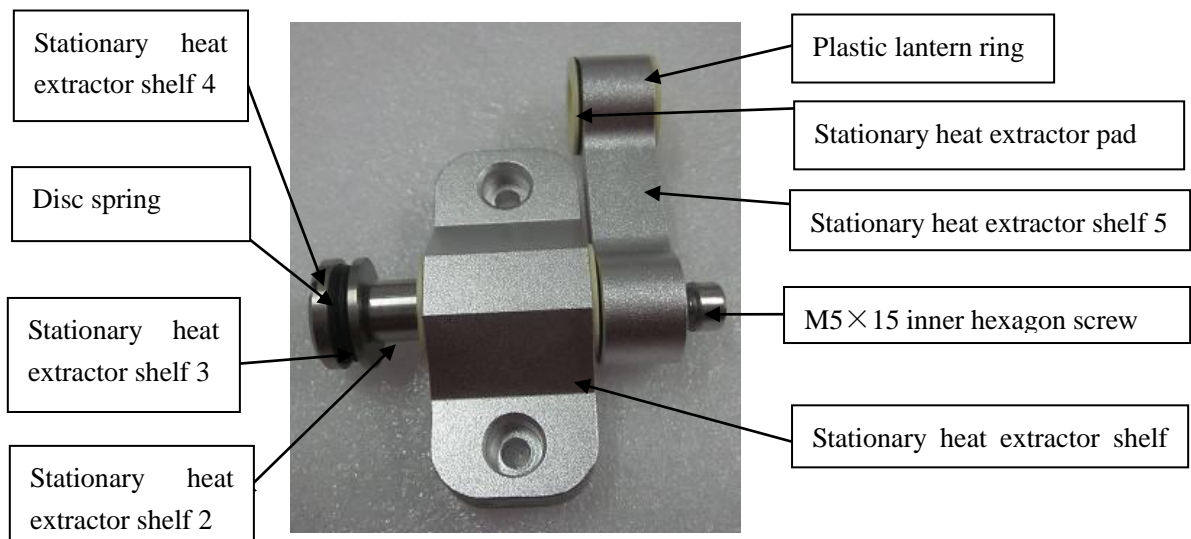

- 、 Install Stationary heat extractor shelf 6 and Stationary heat extractor shelf 7 on Stationary heat extractor shelf 5 with M5×15 inner hexagon screw fastened .





- 、Install the  $\varnothing 2.5 \times 12$  round pin and stationary heat extractor 3 on the Stationary heat extractor 3 separately ; The round pin should expose 2~4mm from the Stationary heat extractor 2 .

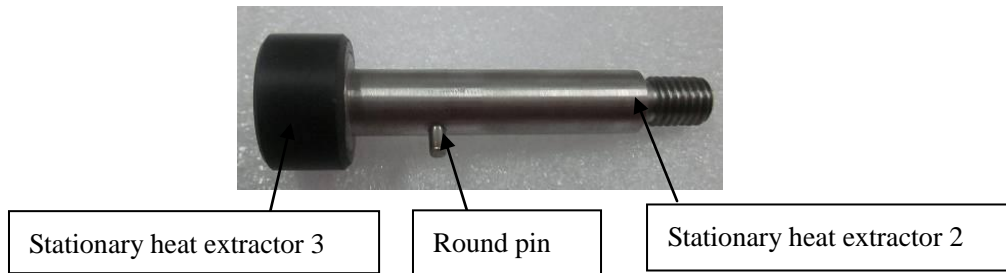

- 、Install the stationary heat extractor 2 ass'y on stationary heat extractor shelf 7 , then twist the stationary heat extractor 1 into stationary heat extractor 2 ass'y .

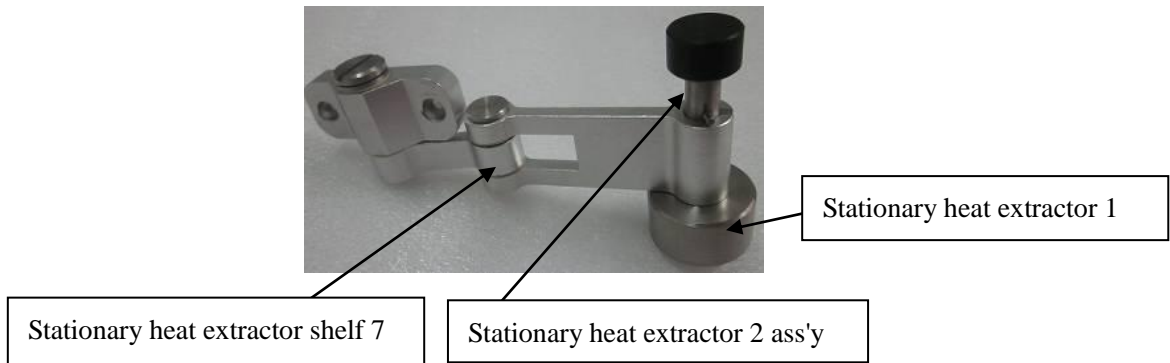

- 、Attention : The stationary heat extractor should rotate flexibly as well as stationary heat extractor slide up and down smoothly .

#### 4.5 Freezing shelf peltier & Sensor Ass'y installation

- 、Insert the sensor with thermally conductive silicon coated into freezing shelf , and then fasten them slightly with M3×6 inner hexagon screw . Note : The sensor should be inserted into the end .

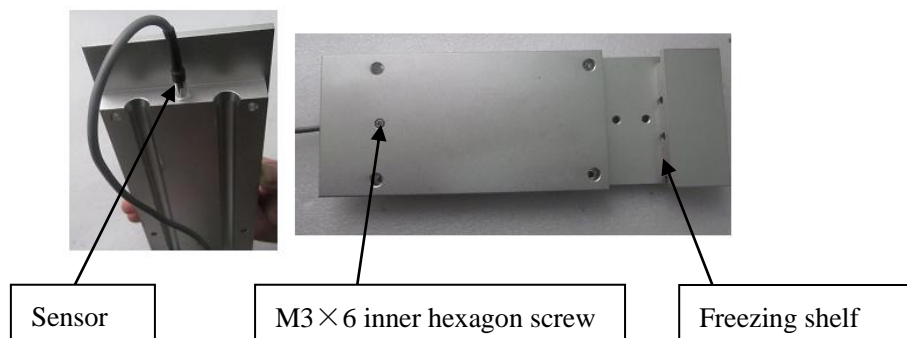

- 、 Fix the class 1 peltier (2 pcs) with thermally conductivity silicone coated on each sides on the freezing shelf . The cable of sensor and peltier should go through the hole of freezing shelf support . Attention : The cold side of peltier must be upward and the hot side must be downward .

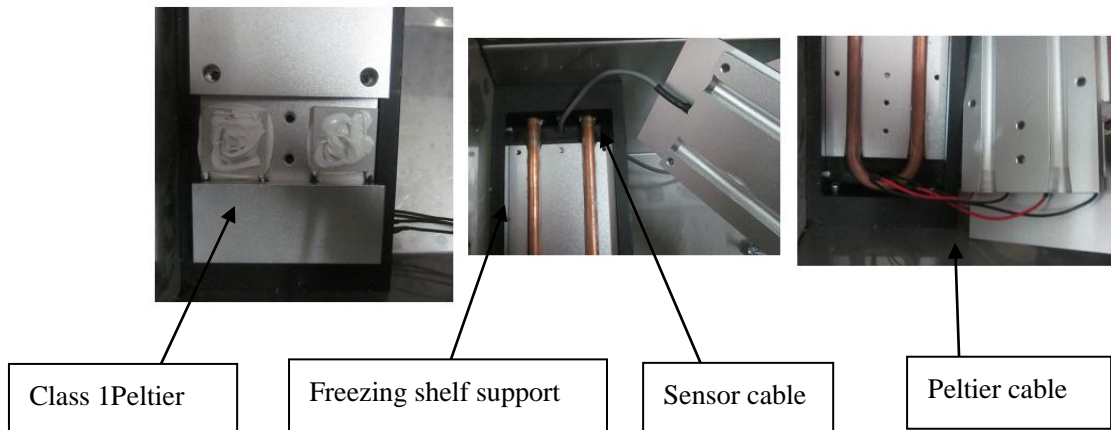

- 、 Install freezing shelf on the freezing shelf support base with M4×14 inner hexagon screw ( 4 pieces ) fastened .Then fasten the rapid freezing shelf with pressure screw and disc spring ( Notice : The disc spring is used to adjust and the quantity is not confirmed ) . At last insert the thermal insulation course in the space between rapid freezing shelf and freezing shelf ; Cover the freezing shelf with freezing lid .

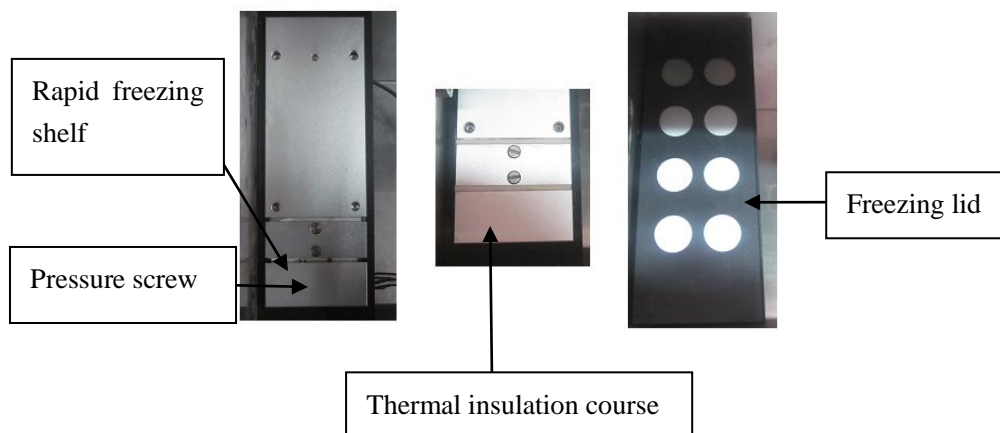

#### 4.6 Chamber sensor Ass'y installation

- 、 Insert the sensor into sensor sleeve with M3×6 inner hexagon screw fastened . Notice : The sensor should be exposed 18.5mm outside .

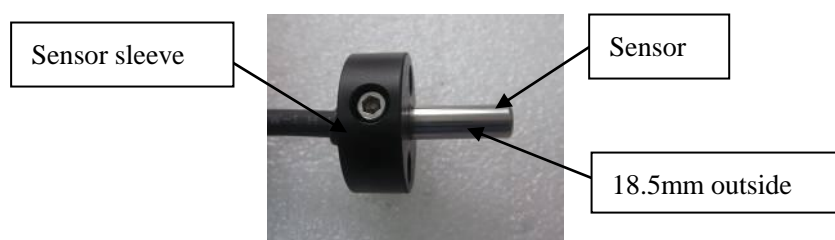

- 、 Install the sensor sleeve inside the chamber with M3×16 countersunk screw fastened .  
Notice : The side with inner hexagon screw should be downward .

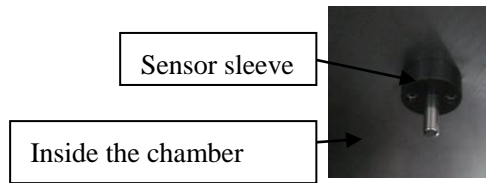

#### 4.7 Clamp peltier Ass'y installation

- 、 Insert the bleeding pipe into radiator insulation jacketing with leaving 5mm outside .

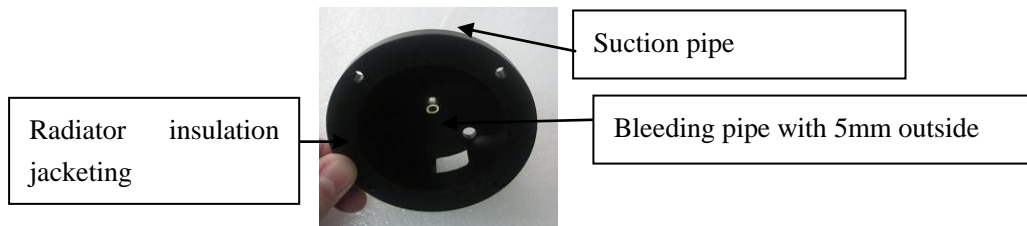

- 、 Install the class 3 peltier with thermal conductivity silicone on hot side on the radiator ; Then install the radiator into radiator insulation jacketing . The cable of sensor and peltier should go through the hole of radiator and radiator insulation jacketing . Notice: The air inlet port of radiator should be align with that of the insulation jacketing .

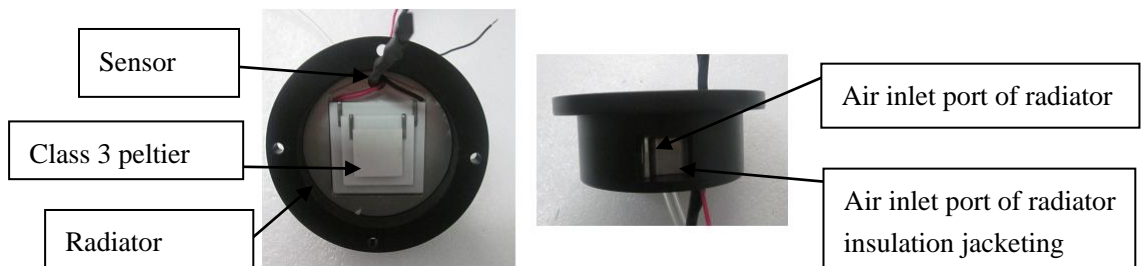

- 、 Install the peltier insulation jacketing into radiator insulation jacketing ; Install clamp 3 into clamp 2 , then twist the sensor in clamp 3 with hot melt adhesive fixed . Grease thermal conductivity silicone on the cold side of the class 3 peltier , then install the clamp 3 on the peltier .  
Notice : Don't crush the peltier during installation .

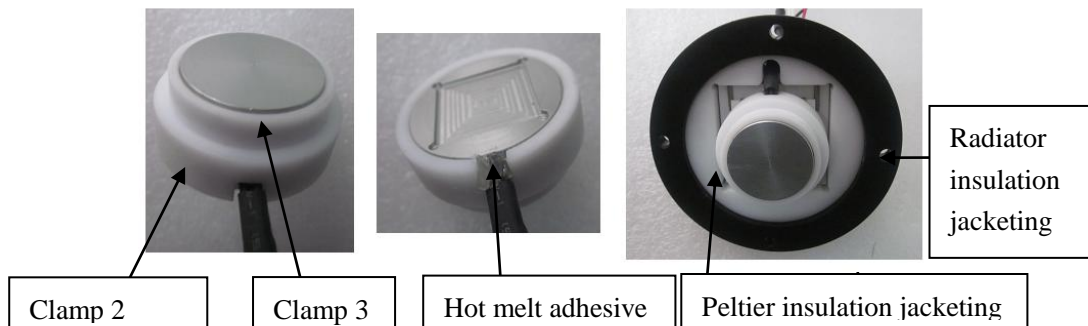

- 、 Install the radiator ass'y into radiator connecting block . Notice : The air inlet port should be align with that of radiator connecting block . Then install the clamp 6 ass'y with M4×20 inner hexagon screw ( 4 pieces ) fastened .

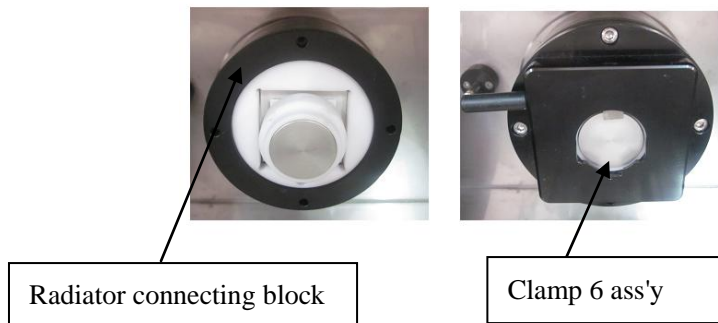

Radiator connecting block

Clamp 6 ass'y

#### 4.8 Fluorescent lamp & UV lamp Ass'y installation

- 、 Loosen the screws ( 8 pieces) on the head housing cover by philip's type screwdriver . Notice : the screws distributes on 4 sides . Open the head housing cover , and pull out the display panel connecting wire and key board connecting wire ;Besides that , it is necessary to pull out the emergency stop button connecting wire for AST 550 .

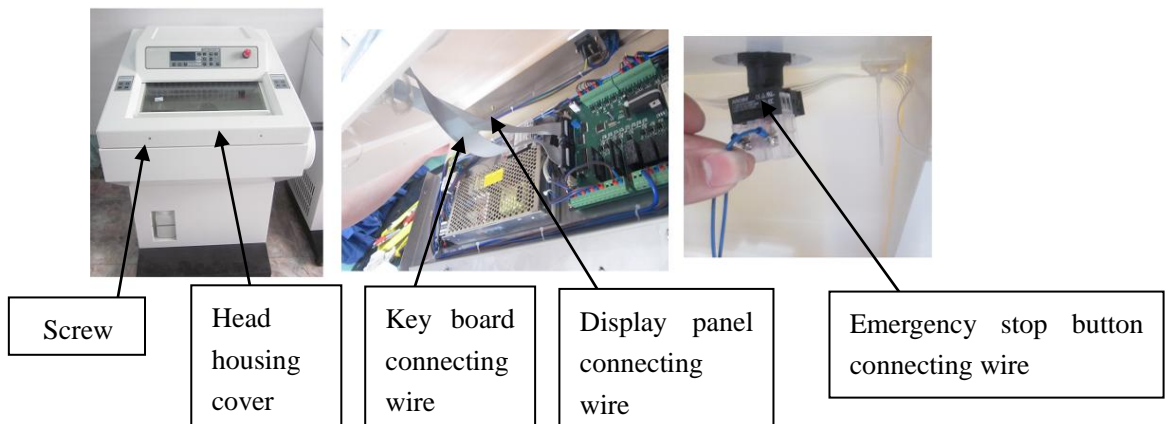

Screw

Head housing cover

Key board connecting wire

Display panel connecting wire

Emergency stop button connecting wire

- 、 Loosen the screws( 6 pieces) on the PCB installation board , take off the board and change fluorescent lamp & UV disinfection lamp . Notice : The model of the fluorescent lamp is T4 12W , and the model of the UV lamp is T5 8W .

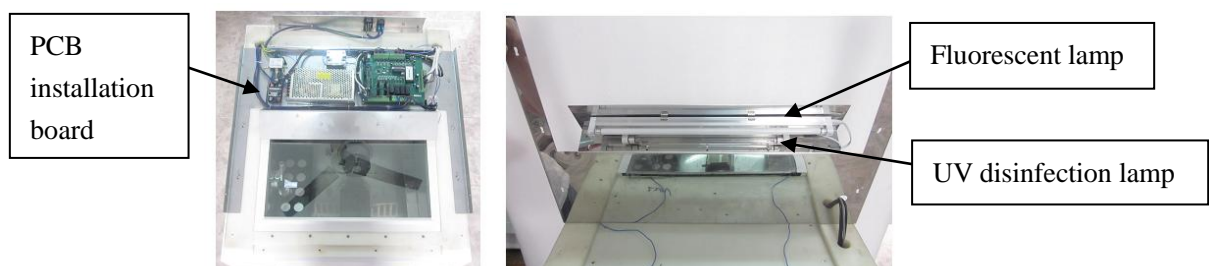

PCB installation board

Fluorescent lamp

UV disinfection lamp

## 4.9 Parameter regulation of driver for advance motor and section motor

- 、Parameter regulation of driver for advance motor : Current 0.30A, 4 segmentation

RMS Current Table				Microstep Table			
Current	SW1	SW2	SW3	MSTEP	SW4	SW5	SW6
0.15A	OFF	ON	ON	1	ON	ON	ON
0.30A	ON	OFF	ON	2	OFF	ON	ON
0.45A	OFF	OFF	ON	4	ON	OFF	ON
0.59A	ON	ON	OFF	8	OFF	OFF	ON
0.74A	OFF	ON	OFF	16	ON	ON	OFF
0.89A	ON	OFF	OFF	32	OFF	ON	OFF
1.06A	OFF	OFF	OFF	64	ON	OFF	OFF

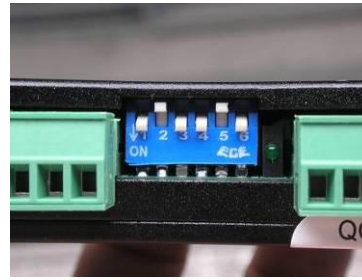

- 、Parameter regulation of driver for section motor :Current 2.0 A, 4 segmentation . half current enabled, self-checking function is off . Notice : This driver is only used in AST 550 .

Current Table				Microstep Table			
Current	SW1	SW2	SW3	MSTEP	SW5	SW6	SW7
1.0A	ON	ON	ON	400	ON	ON	ON
1.5A	OFF	ON	ON	800	OFF	ON	ON
2.0A	ON	OFF	ON	1600	ON	OFF	ON
2.5A	OFF	OFF	ON	3200	OFF	OFF	ON
3.0A	ON	ON	OFF	6400	ON	ON	OFF
3.5A	OFF	ON	OFF	12800	OFF	ON	OFF
4.0A	ON	OFF	OFF	25600	ON	OFF	OFF
4.5A	OFF	OFF	OFF	51200	OFF	OFF	OFF

SW4 ON = Half Current  
OFF = 90% Current

SW8 ON = Self Test  
OFF = Disabled



## 4.10 Wiring diagram

- 、AST500

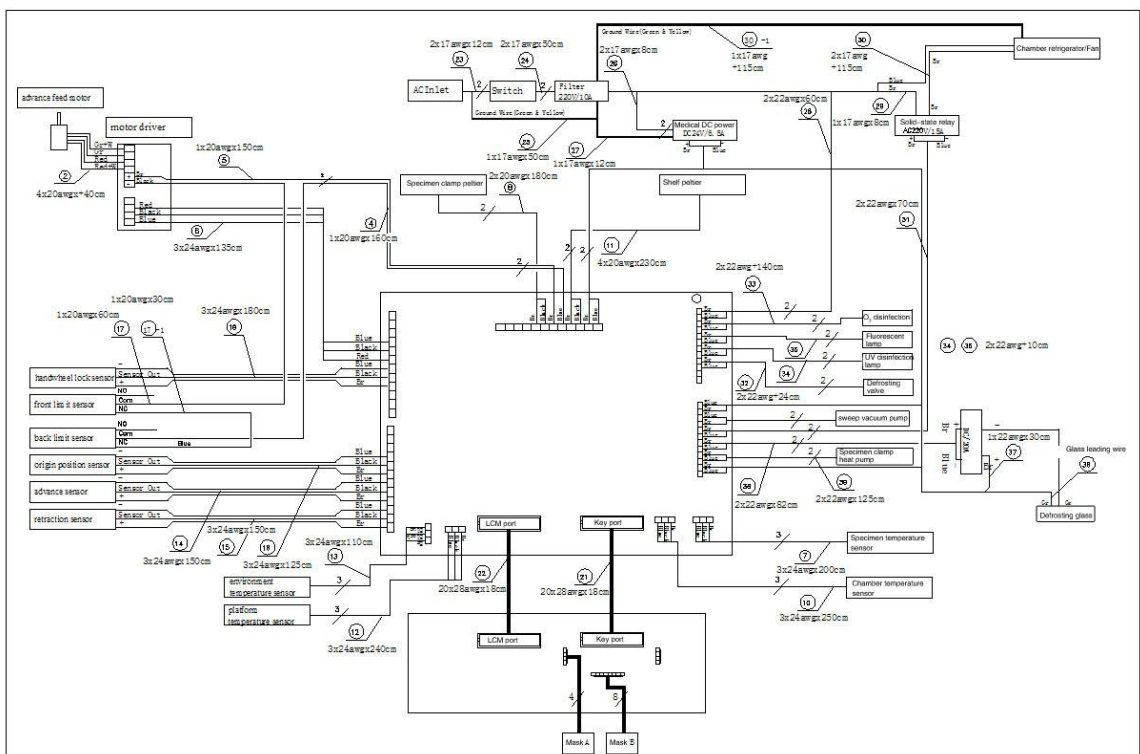

●、AST550

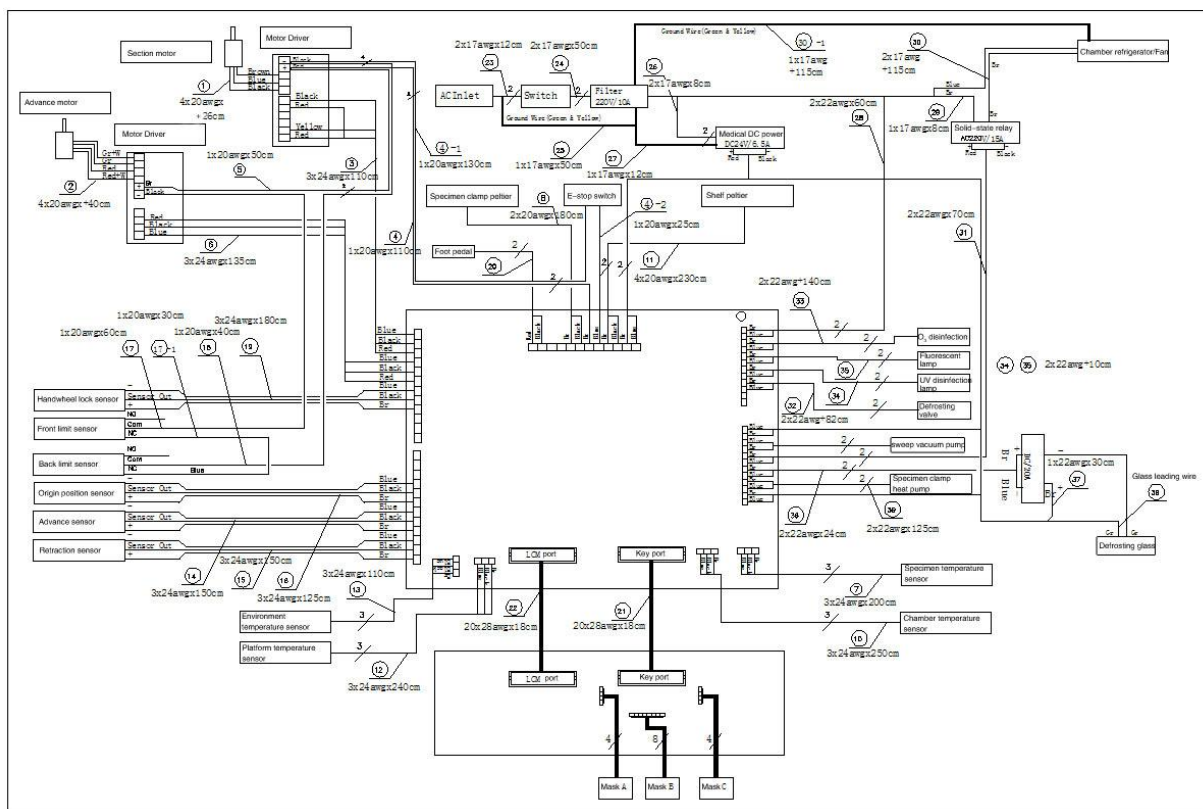

## 5、 Trouble shooting

Here are some common failure causes and solutions, including two aspects: First is that these failures are caused by operator's wrong operation , the second is the failure by the instrument itself.

Kinds	Problem	Possible causes	Corrective action
Can't get the better section.	The thickness is uneven from the second section	The sectioning angle of the knife is too small.	Alternately thick and thin sections are produced. In extreme case, every second section is skipped, being followed by a very thickness. Systematically try wider clearance angle setting until optimum angle width has been found.
		The clamping setting is not reliable	Check if all the screws are tightened.
		Blunt cutting edge	Replace the blade or adjust the position of the blade.
	The section is not continuous	The tissue is too hard.	Reduce the refrigeration time , adjust the chamber temperature .
		The angle between knife and cassette is too large.	Decrease the angle between knife and the embedded specimen.
		The sectioning thickness is too thick.	Adjust the setting thickness

		Blunt cutting edge	Replace the blade or adjust the position of the blade.
	The section is curved or damaged	The cutting edge is irregular	Move the blade in horizon until there is no uneven edge.
	The section is extremely compressed, wrinkled or jammed together.	The blade is dull .	Change the blades or use other position.
		The inclined angle of the knife is too small.	Increase the angle to avoid the incline plane rubbing the embedded specimen.
	Section curl	The space between anti roll plate and blade is too small or anti roll plate is lower than the blade	Adjust the anti roll plate
	Section soften	The temperature of blade or anti roll plate is too high	Extend the refrigeration time of blade or anti roll plate .
	The section sticks to the blade edge or anti roll plate	The blade or anti roll plate is polluted	Clean the blade or anti roll plate
	Section splinter	Temperature is too low for tissue cut	Reduce the refrigeration time and adjust chamber temperature .
	The blade produces sounds when section , and the section are scratched and show vibrated mark	The gradient of the knife is not proper .	Reinstall the blade and adjust the gradient of the blade .
	The tissue block fall off	The embedding medium is not enough	Increase consumption of embedding medium
		The gradient of the knife is not proper .	Adjust the gradient of the blade
	The surface of the section is in wave	The gradient of the knife is not proper	Adjust the gradient of the blade
	The section is narrowing	The space between blade edge and anti-roll plate is uneven	Adjust the space to make it even
Cann't get the better section	The section splits or there is scratch in length orientation.	The blade is uneven.	Sectioning in the even edge of the blade or change the blade
		The blade is polluted.	Clean it
	The section flies away and sticks to the microtome or	It is affected by static.	Increase the surrounding humidity to get rid of the static

	other objects near the microtome		
--	----------------------------------	--	--

Kinds	Problem	Possible causes	Corrective action
Lack of function in electric	No movement after power on	Fuse	Take out the fuse and measure the resistance value by multimeter. If the value is 0 or near to 0 that means the fuse is normal, opposite that means the fuse is broken and need to change a new one. The fuse is broken cause of short circuit, technician must check the cable and confirm no short circuit and switch on later.
		The power cord is not plugged correct or the mainline is open circuit .	Plug the power cord again or replace the mainline .
		The actual input voltage is not match with the specific voltage on the equipment	Contact the professional if the actual input voltage is not match with the specific voltage on the equipment .
		The emergency stop button is pressed down ( AST 550)	Check the emergency stop button
	No display after power on, include LCD and digital tube not light	24V power switch	Open the housing, and test the power switch output 24V or not by multimeter, if no, that means maybe the power switch is broken and need to change a new one.
		Motor	Please use multimeter to test the motor winding and measure the resistance of A+ and A-, B+ and B-. If any value more than 50Ω, that means motor is broken, it need to change a new motor and restart, the machine is work in order
		Driver	Check the indicate light of Motor driver is light or not, if no light, please change a new driver and restart, the machine will work order.
In machinery	The lever can not clamp the knife holder tightly	The holder lever is abrasive .	Take apart the blade holder and adjust the quantity of disc spring on lock pillar 4 or lock pillar 3 to meet the standard ( check the detail in <b>4.1</b> )
	The blade can not clamped tightly	The coordination among the lock lever 1 , lock pillar 1 , blade clamp 2 and blade clamp 1 is not proper	Adjust them to meet the standard ( check the detail in <b>4.1</b> )
In refrigeration	Do not refrigerate	The compressor is broken	Contact withe supplier or repair it by professional staff
		Lack of refrigerating fluid	Add refrigerating fluid
	The compressor stops working	The compressor is in long-term operation or the environment	It can be self-recovery in 15 minutes .



	before the chamber reach to setting temperature	temperature is too high to cause thermal protection	
<p><b>If meet any trouble difficult to solve, please contact with supplier.</b></p>			

## 6、 Clearance& Maintenance

### 6.1 Cleaning the instrument

#### ⊙Cleaning the appearance

Use the wet cloth to clean the areas always be touched when operate the instrument, for example the handle , the base holder locking lever and the storage area on the crust. Use the dry cloth to the dust on the other appearance.

#### ⊙Cleaning the clamp

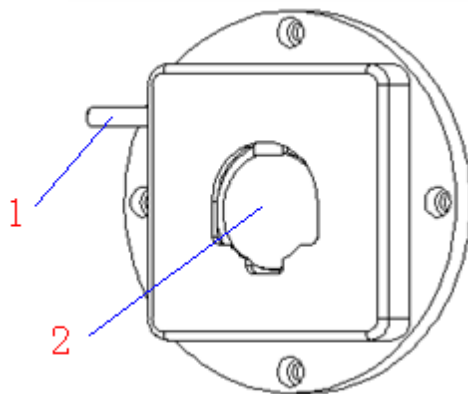

#### Specimen clamp

Position (1) which is often touched when operation , and position (2) which is always contacted with the specimens . These two positions, especially position(2) are very easy to be polluted , so need to be cleaned frequently to ensure ordinary operation .

#### ⊙Cleaning the Blade holder

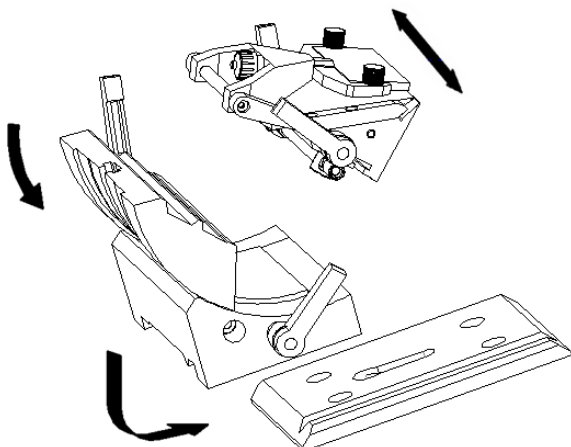

Take down all the parts of the blade holder as it is showed in the picture and then cleaning all the parts separately especially the following easily polluted parts: the sliding guide, fixed pole, blade clamp and the joint of the parts. The cleaning of blade clamp is very important. And remember to clean the blade clamp every time before installing the blade to ensure getting a good sectioning.

To obtain a high quality section, it is important to keep cleaning the instrument. So the user must clean the instrument periodically or irregularly according to the total sectioning quantity to obtain the best section.

- Only authorized and qualified service personnel may access the internal components of the instrument for clearance and maintenance!
- Before clearance and maintenance turn the instrument off , pull out the plug and take down the knife holder and then clean all the parts of instrument separately. The blade must be taken down before cleaning the knife holder.
- Lock the handwheel before each cleaning!
- Do not use any solvents for cleaning!
- Ensure that no liquids enter the interior of the instrument when cleaning!
- Do not turn the instrument on before it is completely dry!

## 6.2 Maintenance

### ⊙ Replacing the Fuses

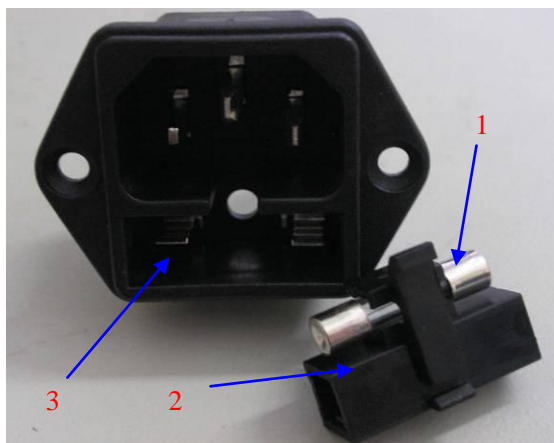

● Put the fuse (1) in the installation part (2) and then insert the installation part into the socket(3).

● Cut off the power supply and pull out the plug before changing the fuse.  
Attention: before changing the fuse, please read the operation manual carefully. And make sure to use the specified type fuse.

### ⊙ Maintenance for the knife holder

Fixed poles, the fixed installations for the knife holder and other parts of the instrument which are frequently used and easily worn, need to be maintained regularly.

Take the fixed poles down and lubricate them with axunge to raise them service life.





## **AMOS SCIENTIFIC PTY.LTD**

37/632 CLAYTON ROAD , CLAYTON SOUTH VIC 3169 , AUSTRALIA

Tel: +61-3-95518850 Fax: +61-3-95516885

ABN 37 159 778 140

[www.amos-scientific.com](http://www.amos-scientific.com)